



SIGNATURE

COLLECTION

INDEX

CONCRETE

- 30 DESIGN CONCRETE
- 42 NEUTRA CONCRETE
- 52 REVIVE CONCRETE XL AND REVIVE CONCRETE

STONE AND METAL

- 70 CORAL STONE
- 78 FLAG STONE
- 88 K-ROCK
- 98 MAREMMA
- 108 SALENTO
- 114 SHINE STONE
- 124 EVOQUE METAL XL AND EVOQUE METAL

SLABS

- 140 PREZIOSI

WOOD

- CIRCLE WOOD 154
- HARD WOOD 162
- SUGI BAN WOOD 170

WALL TILES

- MARAKKESH 180
- SUBWAY 188
- LOFT BRICK 198
- AQUARELA 206
- MILKA 212
- MARE 218
- SPATULA 226
- TENDER 240
- BRAID 246
- LEVANTE 254
- MATERIA 260
- TANDEM 266
- TAUT 272

SIGNATURE
COLLECTION

RAK Ceramics presents Signature Collection, its latest selection of luxury, stylish and high-end products, providing you with unlimited solutions for your design requirements. A boutique ready-made collection always available. Signature Collection captures the essence of quality and showcases the production capabilities of RAK Ceramics, with luxury concepts developed in an impressive range of sizes, finishes, colours, effects and thicknesses to suit every taste.

Developed using precious materials and offering premium performance with contemporary style, Signature Collection is designed to meet the latest architecture and interior design needs.

RAK Ceramics presenta Signature Collection, la più aggiornata e sofisticata selezione di prodotti pensata per fornire infinite soluzioni ad ogni vostra esigenza di progettazione. Una piccola boutique di collezioni complete e sempre disponibili. Signature Collection rappresenta la massima espressione della capacità produttiva e degli standard qualitativi di RAK Ceramics ed offre una ampia gamma di progetti lussuosi e ricercati, una infinita scelta di formati, colori, finiture e spessori in grado di incontrare ogni richiesta.

Sviluppata con materiali preziosi e performance di alto livello, Signature Collection è la soluzione ideale per architetti ed interior designers.



RAK Ceramics présente Signature Collection, la sélection de produits la plus récente et la plus prestigieuse, prévue pour fournir une infinité de solutions pour chacune de vos exigences de planning. Une petite boutique de collections complètes et toujours disponibles. Signature Collection représente l’expression maximale de la capacité de production et des standards qualitatifs de RAK Ceramics, et offre une vaste gamme de projets luxueux et recherchés, un choix infini de formats, de couleurs, de finitions et d’épaisseurs , à même de répondre à toute demande.

Développée avec des matériaux précieux et des performances de niveau élevé, Signature Collection présente la solution idéale pour les architectes et les designers d’intérieur.



RAK Ceramics präsentiert Signature Collection, die neueste und anspruchsvollste Auswahl an Produkten, die dazu bestimmt ist, unendlich viele Lösungen für jedes Ihrer Planungsbedürfnisse zu liefern. Eine kleine Boutique mit ganzheitlichen und stets verfügbaren Kollektionen. Signature Collection repräsentiert den maximalen Ausdruck an Produktionskapazität und qualitativen Standards von RAK Ceramics, und bietet eine breite Palette an luxuriösen und präziösen Projekten, eine unendlich große Auswahl an Formaten, Farben, Oberflächenbeschaffenheiten und Dicken, um jeder Anfrage gerecht zu werden.

Mit wertvollen Materialien und erstklassigen Leistungen entwickelt, bietet Signature Collection die ideale Lösung für Architekten und Innendesigner.

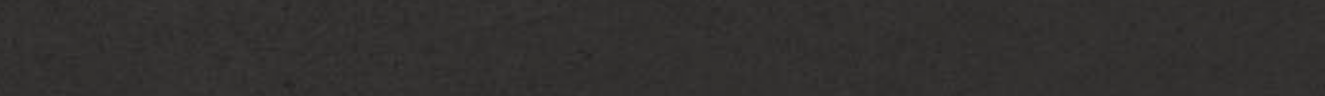

RAK Ceramics presenta Signature Collection, su última selección de productos de lujo, elegantes y de alta gama, que le ofrece soluciones ilimitadas para sus requisitos de diseño. Una colección de boutique confeccionada siempre disponible. Signature Collection captura la esencia de la calidad y muestra las capacidades de producción de RAK Ceramics, con conceptos de lujo desarrollados en una amplia gama de tamaños, acabados, colores, efectos y grosores para todos los gustos.

Desarrollado utilizando materiales preciosos y ofreciendo un rendimiento superior con un estilo contemporáneo, Signature Collection está diseñado para cumplir con las últimas necesidades de arquitectura e interiorismo.

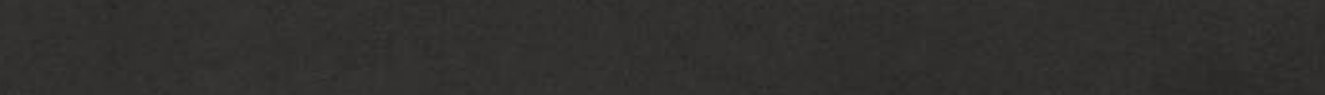

RAK Ceramics представляет коллекцию Signature, её последнюю линейку роскошной, стильной и высококачественной продукции, предоставляя вам неограниченные решения для ваших дизайнерских задач. Вам всегда доступен бутик с коллекцией готовой продукции. Коллекция Signature отражает суть качества и демонстрирует производственные возможности RAK Ceramics роскошными концепциями, разработанными в широком диапазоне размеров, отделки, цветов, эффектов и толщины на любой вкус.

Коллекция Signature, разработана с использованием драгоценных материалов, предлагает превосходное качество и современный стиль и предназначена для удовлетворения самых современных потребностей в архитектуре и дизайне интерьера.

MIX & MATCHING

Are you a rule maker or a rule breaker? Gone are the days of matching everything together, we are living in exciting times with so many different materials and colours available. We already mix furniture or fabrics, why not mix and match our floor, wall and countertop tiles? Signature Collection encourages you to break the rules. Choose different effects, colours and sizes within the same tile collection and mix them with other collections from the Signature range.

Metals, marbles, woods, concrete and resins: an unlimited choice of solutions that help you create unique spaces for your living room, your bathroom, your big or small design ideas and your most challenging projects. Free your aspiration for artistic, luxurious and stylish expression and combine our Signature solutions as creatively as you wish.

Segui le regole o preferisci riscriverle? Sono finiti i giorni in cui tutto doveva essere perfettamente coordinato. Viviamo un tempo ricco di possibilità, colori, materiali diversi tra loro. Accostiamo tra loro mobili e tessuti di stile epoche e colori diversi, perché non farlo anche con pavimenti, rivestimenti e piani di lavoro? Con Signature Collection puoi riscrivere ogni regola. Scegli i tuoi effetti e finiture preferite, colori e formati diversi all'interno dello stesso progetto, mixali con le altre famiglie di prodotto all'interno della gamma Signature. Metalli, marmi, legni, cementi e resine: una scelta illimitata di soluzioni per poter creare spazi irripetibili nel tuo living, bagno, grandi o piccole idee e per i tuoi progetti più ambiziosi.

Suivez-vous les règles ou préférez-vous les récrire? Passés les jours où tout devait être parfaitement coordonné, nous traversons, dès lors, un temps riche en possibilités, en couleurs et en matériaux tous divers. Si nous approchons entre eux des meubles et des tissus de styles, d'époques et de couleurs divers, pourquoi ne pas en faire de même avec les sols, les revêtements et les plans de travail? Par Signature Collection vous rompez toute règle. Choisissez vos effets et vos finitions préférés, des couleurs et formats divers au sein du même projet, et mélangez-les avec d'autres familles de produits à l'intérieur de la gamme Signature. Métaux, marbres, bois, ciments et résines: un choix illimité de solutions, pour créer des espaces uniques dans votre salle de séjour ou salle de bains, pour vos grandes et petites idées et vos projets les plus ambitieux.

Folgen Sie de Regeln oder schreiben Sie sie lieber neu? Die Zeiten, in den alles perfekt koordiniert sein musste sind vorbei, nun durchlaufen wir eine Zeit, reich an Möglichkeiten, Farben und verschiedenen Materialien. Wenn wir Möbel und Materialien verschiedener Stile, Epochen und Farben untereinander anpassen, warum nicht auch Böden, Wandverkleidungen und Arbeitsflächen? Mit Signature Collection brechen Sie alle Regeln. Wählen Sie Ihre liebsten Effekte und Oberflächenbeschaffenheiten, Farben und Formate, innerhalb des gleichen Projekts, und mischen Sie sie mit anderen Produktfamilien innerhalb der Palette Signature. Metalle, Marmor, Holz, Zemente und Harze: eine unbegrenzte Auswahl an Lösungen für einzigartige Räume in Ihrem Wohnbereich und Ihrem Badezimmer, für große oder kleine Ideen und für Ihre ambitioniertesten Projekte.

Eres un creador de reglas o un infractor de reglas? Atrás quedaron los días de combinar todo, vivimos tiempos emocionantes con tantos materiales y colores diferentes disponibles. Ya mezclamos muebles o telas, ¿por qué no mezclar y combinar nuestras baldosas para pisos, paredes y encimeras? Signature Collection lo alienta a romper las reglas. Elija diferentes efectos, colores y tamaños dentro de la misma colección de mosaicos y mézclelos con otras colecciones del rango Firma.

Metales, mármoles, maderas, hormigón y resinas: una variedad ilimitada de soluciones que lo ayudan a crear espacios únicos para su sala de estar, su baño, sus ideas de diseño grandes o pequeñas y sus proyectos más desafiantes. Libere su aspiración por una expresión artística, lujosa y elegante y combine nuestras soluciones Signature tan creativamente como lo desee.

Вы устанавливаете правила или нарушаете их? Прошли те времена, когда было принято, чтобы все элементы дизайна сочетались друг с другом. Теперь нам доступно огромное количество материалов и цветов. Мы уже привыкли комбинировать мебель и ткани, так почему бы не начать комбинировать и не сочетать нашу напольную и настенную плитку и плитку для столешницы? Коллекция Signature призывает вас нарушать правила. Выбирайте любые эффекты, цвета и размеры из одной одной коллекции плитки и смешивайте их с другими коллекциями из ассортимента Signature. Металлы, мрамор, дерево, бетон и смола: неограниченный выбор решений, которые помогут вам создать уникальное пространство для вашей гостиной, ванной комнаты, больших или маленьких дизайнерских идей и самых сложных проектов. Освободите своё самовыражение от рамок, дайте ему возможность для творчества, стиля и роскоши, используя нашу коллекцию Signature настолько креативно, как вы того пожелаете.

WALL: I PREZIOSI OCEAN 120X260 CM
FLOOR: FLAG STONE LIGHT GREY 60X120 CM



WALL: CORAL STONE LIGHT GREY 60X120 CM,
CORAL STONE DARK GREY 60X120 CM
FLOOR: CIRCLE WOOD GREY 19.5X120 CM



WALL: DESIGN CONCRETE WHITE MOSAIC 2.5X10
30X30CM
FLOOR: SUGI BAN WOOD KURO BLACK
19.5X120 CM



WALL: TENDER WHITE 30X100 CM, TENDER
BEIGE DECOR 30X100 CM
FLOOR: MAREMMA DARK BROWN 75X75 CM

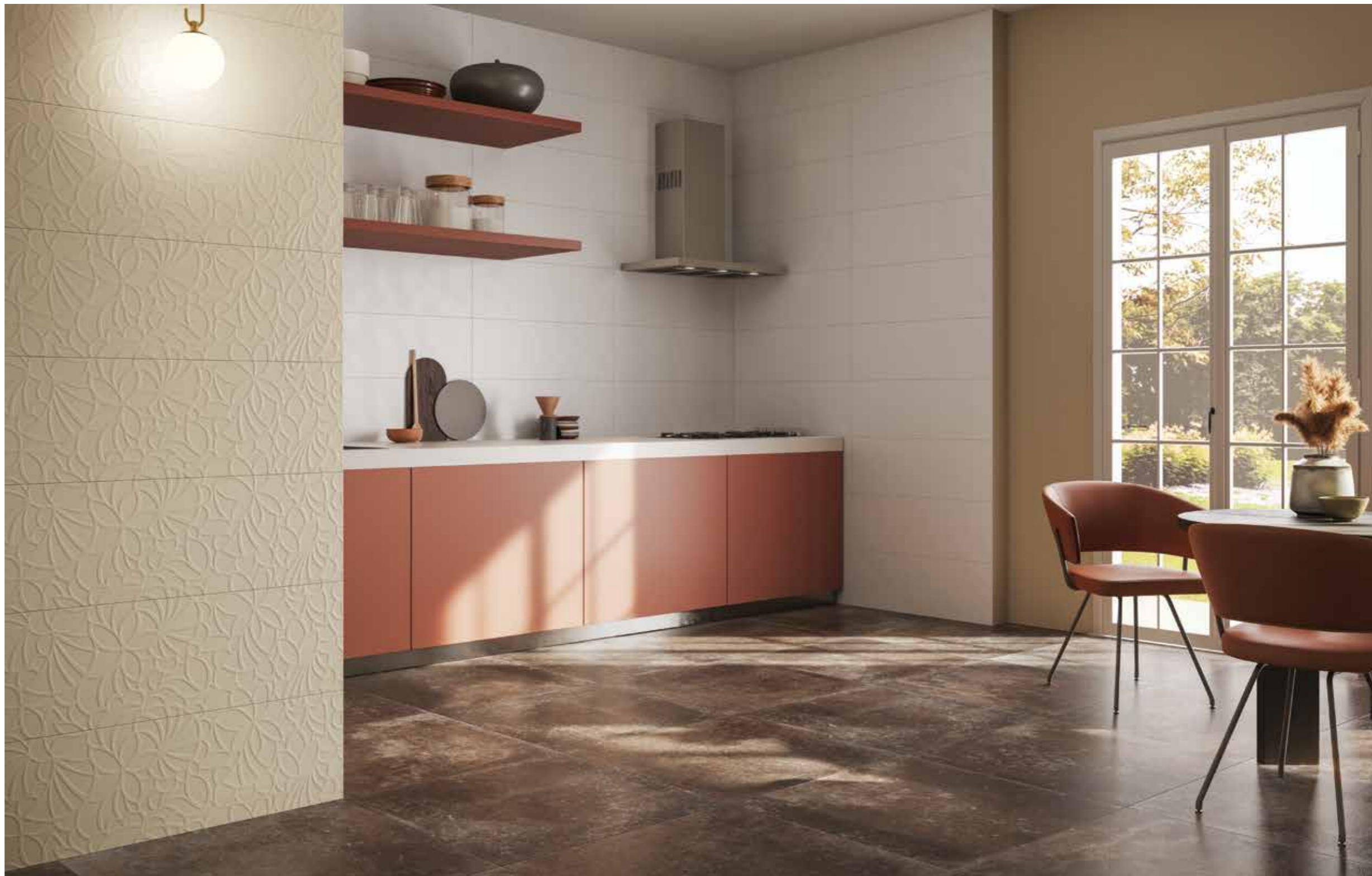

WALL: EVOQUE METAL ICE 60X120 CM
FLOOR: SUGI BAN WOOD KASSHOKU BROWN
19.5X120 CM



WALL: LOFT BRICK WHITE 6.5X26 CM, EVOQUE
METAL XL ICE 120X260 CM
FLOOR: SUGI BAN WOOD SHIRO WHITE
19.5X120 CM, SUGI BAN WOOD BORU BLUE
19.5X120 CM



FLOOR: CORAL STONE DARK GREY 60X60 CM
(20MM THICKNESS)





ICONS

TECHNICAL INFORMATION

INFORMAZIONI TECNICHE
INFORMATIONS TECHNIQUES
TECHNISCHE INFORMATIONEN
INFORMACIÓN TÉCNICA
ТЕХНИЧЕСКАЯ ИНФОРМАЦИЯ

TPOLOGY

TIPOLOGIA | TYPOLOGIE | TYPOLOGIE | TIPOLOGIA |
ТИПОЛОГИЯ



RED BODY CERAMIC TILES
CERAMICA IN PASTA ROSSA
CÉRAMIQUE EN PÂTE ROUGE
ROTSCHERBIGE KERAMIKFLIESEN
CERÁMICA PASTA ROJA
КЕРАМИЧЕСКАЯ ПЛИТКА КРАСНОЕ ТЕЛО



WHITE BODY CERAMIC TILES
CERAMICA IN PASTA BIANCA
CÉRAMIQUE EN PÂTE BLANCHE
WEISSSCHERBIGE KERAMIKFLIESEN
CERÁMICA PASTA BLANCA
КЕРАМИЧЕСКАЯ ПЛИТКА БЕЛОЕ ТЕЛО



PORCELAIN TILES
GRES PORCELLANATO
GRÉS CÉRAMÉ
FEINSTEINZEUG
PORCELÁNICO
КЕРАМИЧЕСКИЙ ГРАНИТ

EDGE

BORDO | BORD | RAND | BORDE | КРАЙ



STRAIGHT
DRITTO
DROIT
GERADE
DERECHO
РОВНАЯ



RECTIFIED
RETTIFICATO
RECTIFIÉ
REKTIFIZIERT
RETIIFICADO
РЕКТИФИЦИРОВАННАЯ

SURFACE STRUCTURE

STRUTTURA | STRUCTURÉ | STRUKTUR |
ESTRUCTURA | СТРУКТУРА ПОВЕРХНОСТИ



SMOOTH
LISCIO
LISSE
GLATT
LISO
ГЛАДКАЯ



LIGHT STRUCTURE
STRUTTURA LEGGERA
STRUCTURE LÉGÈRE
LEICHTE STRUKTUR
ESTRUCTURA LIGERA
ЛЕГКАЯ СТРУКТУРА



HEAVY STRUCTURE
STRUTTURA PESANTE
STRUCTURE LOURDE
GROBE STRUKTUR
ESTRUCTURA PESADA
ГРУБАЯ СТРУКТУРА

FINISH

FINITURA
FINITION
OBERFLÄCHE
ACABADO
ОТДЕЛКА



NATURAL
NATURALE
NATUREL
NATUR
MATT
НАТУРАЛЬНАЯ



LAPPATO
LAPPATO
ADOUCI
ANPOLIERT
ESMERILLADO
ЛАППАТИРОВАННАЯ



FULL LAPPATO
LAPPATURA A CAMPO PIENO
POLI
FULL LAPPATO
LAPPATO
РЕЛЬЕФНАЯ

SURFACE LOOK

ASPETTO SUPERFICIALE
ASPECT SUPERFICIEL
AUSSEHEN DER OBERFLÄCHE
ASPECTO SUPERFICIAL
ТИП ПОВЕРХНОСТИ



MATT
OPACO
MAT
MATT
OPACO
МАТОВАЯ



SATIN
SATINATO
SATINÉ
SATIN
SATINADO
САТИНОВАЯ



GLOSSY
LUCIDO
BRILLANT
GLANZEND
BRILLANTE
ГЛЯНЦЕВАЯ



HIGH GLOSSY
MOLTO LUCIDO
HAUTE BRILLANCE
HOCHGLANZ
MUY BRILLANTE
ВЫСОКО-ГЛЯНЦЕВАЯ

COLOUR VARIATIONS

VARIAZIONI CROMATICHE
VARIATIONS CHROMATIQUES
FARBVARIATIONEN
VARIACIONES CROMÁTICAS
ЦВЕТОВЫЕ ИЗМЕНЕНИЯ



V1
EVEN



V2
LIGHT



V3
MEDIUM



V4
STRONG

INDICATIONS FOR USE

INDICAZIONI D'USO
INSTRUCTIONS D'UTILISATION
ANWENDUNGSGEBIET
INDICACIONES DE USO
УКАЗАНИЯ ПО ПРИМЕНЕНИЮ



COUNTERTOP SURFACE
PIANO DI LAVORO
PLAN DE TRAVAIL
ARBEITSPLATTE
ENCIMERA
СТОЛЕШНИЦА



WALL TILES
RIVESTIMENTO
REVÊTEMENT
WAND
RIVESTIMIENTO
НАСТЕННАЯ ПЛИТКА



FLOOR TILES
PAVIMENTO
SOL
BODEN
PISO
НАПОЛЬНАЯ ПЛИТКА

SUGGESTED APPLICATIONS

DESTINAZIONI D'USO | DESTINATION | ANWENDUNGSBEREICH | LUGAR DE EMPLEO | НАЗНАЧЕНИЕ



DOMESTIC PURPOSE
ABITAZIONI
HABITATION
WOHNBEREICH
HABITACIÓN
ВНУТРИ ПОМЕЩЕНИЙ



OUTDOOR
ESTERNI
EXTÉRIEUR
AUSSENBEREICH
EXTERIOR
СНАРУЖИ ПОМЕЩЕНИЙ



LIGHT COMMERCIAL TRAFFIC AREA
COMMERCIALE LEGGERO
PASSAGE LÉGER
GEWERBLICHER BEREICH
PEQUEÑA SUPERFICIE COMERCIAL
ОБЩЕСТВЕННЫЕ ПОМЕЩЕНИЯ С НИЗКОЙ ПРОХОДИМОСТЬЮ



HEAVY COMMERCIAL TRAFFIC AREA
COMMERCIALE PESANTE
PASSAGE INTENSE
GEWERBLICHER BEREICH MIT HOHER BEANSPRUCHUNG
GRANDE SUPERFICIZ COMERCIAL
ОБЩЕСТВЕННЫЕ ПОМЕЩЕНИЯ С ВЫСОКОЙ ПРОХОДИМОСТЬЮ



FACADE
FACCIATE ESTERNE
FAÇADE
FACSADE
FACHADA
ФАСАД

IN PRINTING, COLOUR OF THE PRODUCTS MAY DIFFER SLIGHTLY FROM ACTUAL, PICTURES ARE ONLY FOR REFERENCE.
NELLA STAMPA, IL COLORE DEI PRODOTTI PUÒ LEGGERMENTE DIFFERIRE DAL COLORE REALE. LE IMMAGINI SONO PURAMENTE INDICATIVE
LA COULEUR DES PRODUITS PEUT DIFFÉRER LÉGÈREMENT DE LA COULEUR RÉELLE, LES IMAGES SONT UTILISÉES UNIQUEMENT POUR RÉFÉRENCE
DIE FARBEN DER PRODUKTE KÖNNEN VOM ORIGINAL ABWEICHEN, DIE BILDER DIENEN NUR ALS REFERENZ
EL COLOR DE LOS PRODUCTOS PUEDE VARIAR LEVEMENTE RESPECTO AL REAL, LAS IMÁGENES SON SÓLO DE REFERENCIA
В ПЕЧАТНОЙ ВЕРСИИ ЦВЕТ ПРОДУКТОВ МОЖЕТ ОТЛИЧАТЬСЯ НЕМНОГО ОТ ФАКТИЧЕСКОГО, ИЗОБРАЖЕНИЯ ТОЛЬКО ДЛЯ СПРАВКИ

SIGNATURE
COLLECTION

CONCRETE



DESIGN CONCRETE

FLOOR: DESIGN CONCRETE LIGHT GREY
60X60 CM



FLOOR: DESIGN CONCRETE IVORY 60X60 CM
OUTDOOR



DESIGN CONCRETE

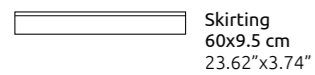
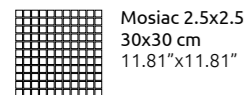
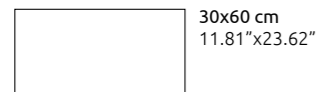
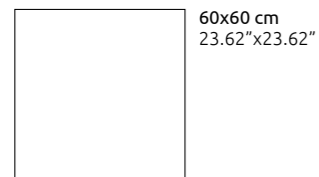
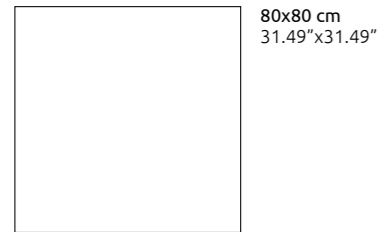
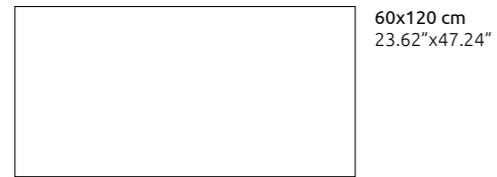

DESIGN CONCRETE WHITE



DESIGN CONCRETE IVORY



DESIGN CONCRETE LIGHT GREY



DESIGN CONCRETE SAND



DESIGN CONCRETE GREY



DESIGN CONCRETE



DESIGN CONCRETE
MOSAIC 2.5X2.5*

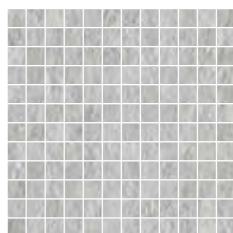

30X30 CM / 11.81"X11.81"

DESIGN CONCRETE
MOSAIC 2.5X10*

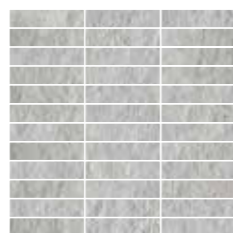

30X30 CM / 11.81"X11.81"

*Available in all colours | Disponibile in tutti i colori | Disponible dans toutes les couleurs |
In allen Farben erhältlich | Disponible en todos los colores | Доступно во всех цветах

PACKAGING | IMBALLI | EMBALLAGES | VERPAKUNGEN | УПАКОВКА

Sizes (cm)	Thickness (mm)	Pz X	M ² X	Kg X	RM X	X Sq. Pallet	M ² X Sq. Pallet	kg X Sq. Pallet	X Eu. Pallet	M ² X Eu. Pallet	kg X Eu. Pallet
60X120	9	2	1.44	30.00	-	-	-	-	30	43.20	921.00
80x80	9	3	1.92	40.00	-	-	-	-	30	57.60	1221.00
60X60	9	4	1.44	30.00	-	-	-	-	30	43.20	921.00
60X60	20.00	2	0.72	32.00	-	-	-	-	30	21.60	1,000.00
30X60	9	6	1.08	23.00	-	-	-	-	48	51.84	1125.00
SKIRTING 60x9.5	9	18	1.08	21.00	10.8	48	51.84	1008	45	48.6	945.00
MOSAIC 30X30	9	10	-	14.00	-	-	-	-	48	-	672.00

Name	Code	Size(CM)	Code	Size(CM)	Code	Size(CM)	Code	Size(CM)
DESIGN CONCRETE WHITE	A12GZDCC-WH0.M2S5R	60x120	A05GZDCC-WHE.M7X0R	80x80	A06GZDCC-WH0.M2R	60x60	A09GZDCC-WH0.M2R	30x60
DESIGN CONCRETE LIGHT GREY	A12GZDCC-LGY.M2S5R	60x120	A05GZDCC-LIG.M7X0R	80x80	A06GZDCC-LGY.M2R	60x60	A09GZDCC-LGY.M2R	30x60
DESIGN CONCRETE GREY	A12GZDCC-GY0.M2S5R	60x120	A05GZDCC-GRY.M7X0R	80x80	A06GZDCC-GY0.M2R	60x60	A09GZDCC-GY0.M2R	30x60
DESIGN CONCRETE IVORY	A12GZDCC-IV0.M2S5R	60x120	A05GZDCC-IVO.M7X0R	80x80	A06GZDCC-IV0.M2R	60x60	A09GZDCC-IV0.M2R	30x60
DESIGN CONCRETE SAND	A12GZDCC-SN0.M2S5R	60x120	A05GZDCC-SND.M7X0R	80x80	A06GZDCC-SN0.M2R	60x60	A09GZDCC-SN0.M2R	30x60

Name	Code	Size(CM)	Name	Code	Size(CM)
DESIGN CONCRETE WHITE MOSAIC 2.5X2.5	AM-GZDCC-WH.2R/2H	30x30	DESIGN CONCRETE WHITE MOSAIC 2.5X10	AM-GZDCC-WH.2R2/10	30x30
DESIGN CONCRETE LIGHT GREY MOSAIC 2.5X2.5	AM-GZDCC-LGY.2R/2H	30x30	DESIGN CONCRETE LIGHT GREY MOSAIC 2.5X10	AM-GZDCC-LG.2R2/10	30x30
DESIGN CONCRETE GREY MOSAIC 2.5X2.5	AM-GZDCC-GY.2R/2H	30x30	DESIGN CONCRETE GREY MOSAIC 2.5X10	AM-GZDCC-GY.2R2/10	30x30
DESIGN CONCRETE IVORY MOSAIC 2.5X2.5	AM-GZDCC-IV.2R/2H	30x30	DESIGN CONCRETE IVORY MOSAIC 2.5X10	AM-GZDCC-IV.2R2/10	30x30
DESIGN CONCRETE SAND MOSAIC 2.5X2.5	AM-GZDCC-SN.2R/2H	30x30	DESIGN CONCRETE SAND MOSAIC 2.5X10	AM-GZDCC-SN.2R2/10	30x30

Name	Code	Size(CM)	Name	Code	Size(CM)
DESIGN CONCRETE WHITE STEP	AST-12ZDCC-WH0.2RA	30x120	DESIGN CONCRETE WHITE SKIRTING	ASK06GZDCC-WH0.2AN	60x9.5
DESIGN CONCRETE LIGHT GREY STEP	AST-12ZDCC-LGY.2RA	30x120	DESIGN CONCRETE LIGHT GREY SKIRTING	ASK06GZDCC-LGY.2AN	60x9.5
DESIGN CONCRETE GREY STEP	AST-12ZDCC-GY0.2RA	30x120	DESIGN CONCRETE GREY SKIRTING	ASK06GZDCC-GY0.2AN	60x9.5
DESIGN CONCRETE IVORY STEP	AST-12ZDCC-IV0.2RA	30x120	DESIGN CONCRETE IVORY SKIRTING	ASK06GZDCC-IV0.2AN	60x9.5
DESIGN CONCRETE SAND STEP	AST-12ZDCC-SN0.2RA	30x120	DESIGN CONCRETE SAND SKIRTING	ASK06GZDCC-SN0.2AN	60x9.5

DESIGN CONCRETE

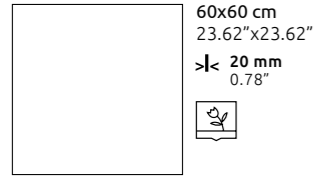

DESIGN CONCRETE LIGHT GREY



DESIGN CONCRETE DARK GREY



DESIGN CONCRETE IVORY



Name	Code	Size(CM)	
DESIGN CONCRETE LIGHT GREY	A06GZDCC-LGY.M2T5R	60x60	R11
DESIGN CONCRETE DARK GREY	A06GZDCC-DGY.M2T5R	60x60	R11
DESIGN CONCRETE IVORY	A06GZDCC-IV0.M2T5R	60x60	R11

PACKAGING | IMBALLI | EMBALLAGES | VERPAKUNGEN | УПАКОВКА

Sizes (cm)	Thickness (mm)	Pz X	M² X	Kg X	X Eu. Pallet	M² X Eu. Pallet	kg X Eu. Pallet
60X60	20.00	2	0.72	32.00	30	21.60	1,000.00

FLOOR: DESIGN CONCRETE IVORY 60X60 CM (R11)



WALL: NEUTRA IVORY 60X120 CM FLOOR: NEUTRA CONCRETE LIGHT GREY 60X120 CM



NEUTRA CONCRETE

WALL: NEUTRA CONCRETE LIGHT GREY 60X120 CM, NEUTRA CONCRETE GREY 19.5X120 CM
NEUTRA IVORY 60X120 CM
FLOOR: NEUTRA CONCRETE IVORY 60X120 CM



WALL: NEUTRA CONCRETE LIGHT GREY 60X120 CM, NEUTRA CONCRETE GREY 19.5X120 CM
NEUTRA IVORY 60X120 CM
FLOOR: NEUTRA CONCRETE IVORY 60X120 CM



NEUTRA CONCRETE

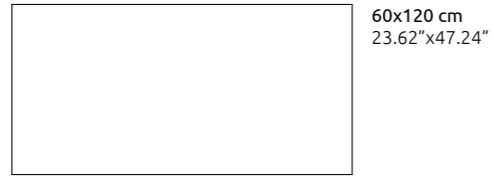

60x120 cm
23.62"x47.24"



19.5x120 cm
7.67"x47.24"

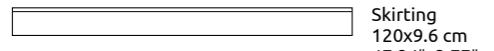

Skirting
120x9.6 cm
47.24"x3.77"

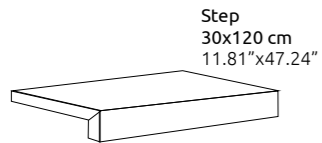

Step
30x120 cm
11.81"x47.24"



Riser
5x120 cm
1.96"x47.24"

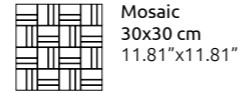

Mosaic
30x30 cm
11.81"x11.81"

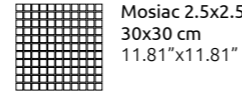

Mosaic 2.5x2.5
30x30 cm
11.81"x11.81"

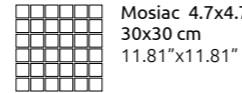

Mosaic 4.7x4.7
30x30 cm
11.81"x11.81"

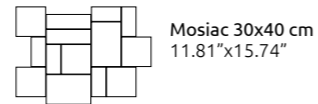

Mosaic 30x40 cm
11.81"x15.74"



Mosaic 30x45 cm
11.81"x17.71"

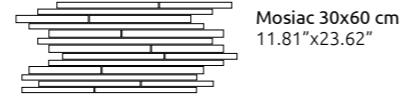

Mosaic 30x60 cm
11.81"x23.62"

NEUTRA CONCRETE LIGHT GREY



NEUTRA CONCRETE IVORY



NEUTRA CONCRETE GREY



NEUTRA CONCRETE BEIGE



NEUTRA IVORY *



* AVAILABLE IN 60X120CM ONLY

NEUTRA CONCRETE



NEUTRA CONCRETE
MOSAIC 2.5X2.5*

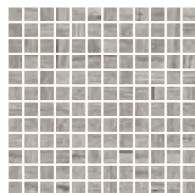

30X30 CM / 11.81"X11.81"

NEUTRA CONCRETE
MOSAIC 4.7X4.7*

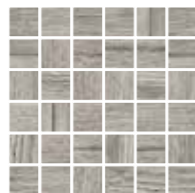

30X30 CM / 11.81"X11.81"

NEUTRA CONCRETE
MOSAIC*



30X30 CM / 11.81"X11.81"

NEUTRA CONCRETE
MOSAIC 30x40*



30X40 CM / 11.81"X15.74"

NEUTRA CONCRETE
MOSAIC 30x45*



30X45 CM / 11.81"X17.71"

NEUTRA CONCRETE
MOSAIC 30x60*



30X60 CM / 11.81"X23.62"

*Available in all colours | Disponibile in tutti i colori | Disponible dans toutes les couleurs | In allen Farben erhältlich | Disponible en todos los colores | Доступно во всех цветах

PACKAGING | IMBALLI | EMBALLAGES | VERPAKUNGEN | УПАКОВКА

Size (cm)	Thickness (mm)	Pz X	M² X	Kg X	RM X	X Sq. Pallet	M² X Sq. Pallet	kg X Sq. Pallet	X Eu. Pallet	M² X Eu. Pallet	kg X Eu. Pallet
60x120	9	2	1.44	30.00	-	-	-	-	30	43.20	921.00
19.5x120	9	5	1.17	25.00	-	-	-	-	36	42.12	921.00
MOSAIC 30x30	9	10	-	14.00	-	-	-	-	48	-	672.00
MOSAIC 30x40	9	8	-	13.00	-	-	-	-	48	-	624.00
MOSAIC 30x45	9	6	-	15.00	-	-	-	-	30	-	450.00
MOSAIC 30x60	9	6	-	17.00	-	-	-	-	30	-	510.00
STEPS 19.5x120	9	2	0.72	20.00	-	-	-	-	-	-	-
STEPS 30x60	9	6	-	18.00	-	-	-	-	48	-	900.00

Name	Code	Size(CM)	Code	Size(CM)
NEUTRA CONCRETE LIGHT GREY	A12GNTRC-LIG.A6X5R	60X120	A99GNTRC#LIG.A6X5R	19.5X120
NEUTRA CONCRETE GREY	A12GNTRC-GRY.A6X5R	60X120	A99GNTRC#GRY.A6X5R	19.5X120
NEUTRA CONCRETE IVORY	A12GNTRC-IVO.A6X5R	60X120	A99GNTRC#IVO.A6X5R	19.5X120
NEUTRA CONCRETE BEIGE	A12GNTRC-BEE.A6X5R	60X120	A99GNTRC#BEE.A6X5R	19.5X120
NEUTRA IVORY	A12GNUTM-GRY.MDX5R	60X120		

Name	Code	Size(CM)	Name	Code	Size(CM)
NEUTRA CONCRETE LIGHT GREY MOSAIC 2.5X2.5	AGMZZTYLRLIG030491	30x30	NEUTRA CONCRETE LIGHT GREY MOSAIC 4.7X4.7	AGMZZNTRCLIG030443	30x30
NEUTRA CONCRETE GREY MOSAIC 2.5X2.5	AGMZZTYLRGRY030492	30x30	NEUTRA CONCRETE GREY MOSAIC 4.7X4.7	AGMZZNTRCRGY030444	30x30
NEUTRA CONCRETE IVORY MOSAIC 2.5X2.5	AGMZZTYLRIVO030489	30x30	NEUTRA CONCRETE IVORY MOSAIC 4.7X4.7	AGMZZNTRCIVO030441	30x30
NEUTRA CONCRETE BEIGE MOSAIC 2.5X2.5	AGMZZTYLRBEE030490	30x30	NEUTRA CONCRETE BEIGE MOSAIC 4.7X4.7	AGMZZNTRCBEE030442	30x30
NEUTRA CONCRETE LIGHT GREY MOSAIC	AGMZZTYLRLIG030537	30x30	NEUTRA CONCRETE LIGHT GREY MOSAIC 30X40	AGMZZTYLRLIG030588	30x30
NEUTRA CONCRETE GREY MOSAIC	AGMZZTYLRGRY030538	30x30	NEUTRA CONCRETE GREY MOSAIC 30X40	AGMZZTYLRGRY030589	30x30
NEUTRA CONCRETE IVORY MOSAIC	AGMZZTYLRIVO030535	30x30	NEUTRA CONCRETE IVORY MOSAIC 30X40	AGMZZTYLRIVO030586	30x30
NEUTRA CONCRETE BEIGE MOSAIC	AGMZZTYLRBEE030536	30x30	NEUTRA CONCRETE BEIGE MOSAIC 30X40	AGMZZTYLRBEE030587	30x30
NEUTRA CONCRETE LIGHT GREY MOSAIC 30X45	AGMZZTYLRLIG030904	30x45	NEUTRA CONCRETE LIGHT GREY MOSAIC 30X60	AGMZZTYLRLIG030848	30x60
NEUTRA CONCRETE GREY MOSAIC 30X45	AGMZZNTRCRGY032707	30x45	NEUTRA CONCRETE GREY MOSAIC 30X60	AGMZZTYLRGRY030849	30x60
NEUTRA CONCRETE IVORY MOSAIC 30X45	AGMZZTYLRIVO030905	30x45	NEUTRA CONCRETE IVORY MOSAIC 30X60	AGMZZTYLRIVO030846	30x60
NEUTRA CONCRETE BEIGE MOSAIC 30X45	AGMZZTYLRBEE030903	30x45	NEUTRA CONCRETE BEIGE MOSAIC 30X60	AGMZZTYLRBEE030847	30x60
NEUTRA CONCRETE LIGHT GREY STEP	AGTZZNTRCLIG030340	30x120	NEUTRA CONCRETE LIGHT GREY RISER	AGRZZNTRCLIG030326	5x120
NEUTRA CONCRETE GREY STEP	AGTZZNTRCRGY030341	30x120	NEUTRA CONCRETE GREY RISER	AGRZZNTRCRGY030327	5x120
NEUTRA CONCRETE IVORY STEP	AGTZZNTRCIVO030338	30x120	NEUTRA CONCRETE IVORY RISER	AGRZZNTRCIVO030324	5x120
NEUTRA CONCRETE BEIGE STEP	AGTZZNTRCBEE030339	30x120	NEUTRA CONCRETE BEIGE RISER	AGRZZNTRCBEE030325	5x120
NEUTRA CONCRETE LIGHT GREY SKIRTING	AGSZZNTRCLIG031003	120x9.6			
NEUTRA CONCRETE GREY SKIRTING	AGSZZNTRCRGY031004	120x9.6			
NEUTRA CONCRETE IVORY SKIRTING	AGSZZNTRCIVO031001	120x9.6			
NEUTRA CONCRETE BEIGE SKIRTING	AGSZZNTRCBEE031002	120x9.6			



REVIVE CONCRETE
REVIVE CONCRETE XL

FLOOR: REVIVE CONCRTE XL CONCRETE GREY 120X120 CM.

WALL: REVIVE CONCRETE XL ACTIVE WHITE
120X240 CM.
FLOOR: REVIVE CONCRTE XL CONCRETE GREY
120X120 CM.



WALL: REVIVE CONCRETE SUMMER SAND
60X1200CM
FLOOR: REVIVE CONCRETE CLOUD GREY
60X60CM



REVIVE CONCRETE XL

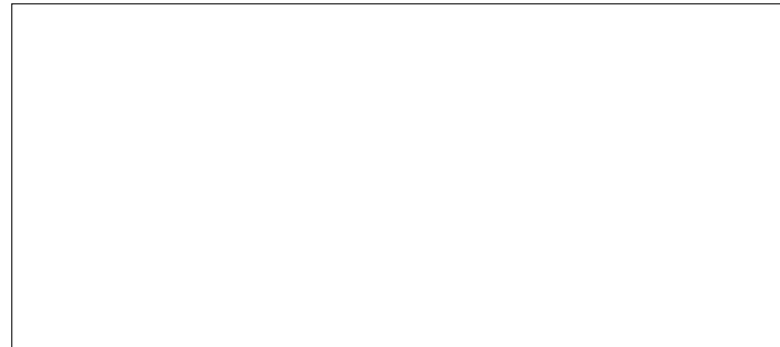

135x305 cm
53.14"x120"



>|< 14.5 mm
0.57"

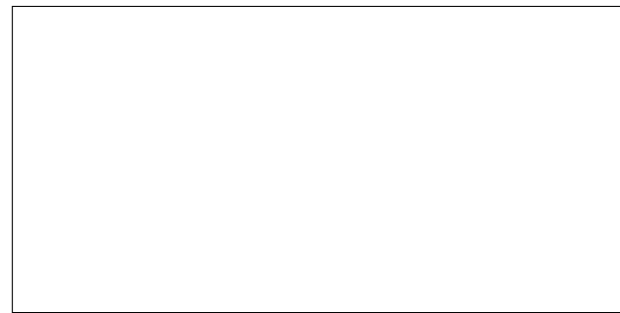
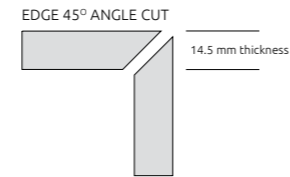

120x240 cm
47.24"x94.48"

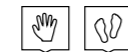

>|< 9 mm
0.35"

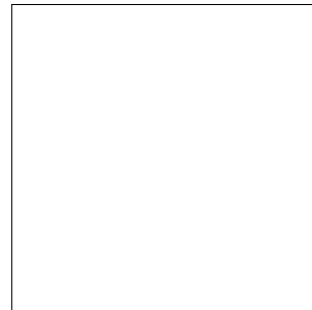

120x120 cm
47.24"x47.24"



>|< 9 mm
0.35"

REVIVE CONCRETE XL ACTIVE WHITE



REVIVE CONCRETE XL CONCRETE GREY



REVIVE CONCRETE XL SUMMER SAND



Name	Code	Thickness(MM)	Size(CM)
REVIVE CONCRETE XL ACTIVE WHITE	AGB83REVXACWZMSNLR	14.5	135x305
REVIVE CONCRETE XL CONCRETE GREY	AGB83REVXCRGZMSNLR	14.5	135x305
REVIVE CONCRETE XL SUMMER SAND	AGB83REVXSMSZMSNLR	14.5	135x305
REVIVE CONCRETE XL ACTIVE WHITE	AGB46REVCACWZMLC3R	9	120x240
REVIVE CONCRETE XL CONCRETE GREY	AGB46REVCCRZMLC3R	9	120x240
REVIVE CONCRETE XL SUMMER SAND	AGB46REVCSMSZMLC3R	9	120x240
REVIVE CONCRETE XL ACTIVE WHITE	A22GREVC-ACW.M0X5R	9	120x120
REVIVE CONCRETE XL CONCRETE GREY	A22GREVC-CRG.M0X5R	9	120x120
REVIVE CONCRETE XL SUMMER SAND	A22GREVC-SMS.M0X5R	9	120x120

Packaging are available upon request | L'imballaggio è disponibile su richiesta | Les emballages sont disponibles sur demande | Verpackungen sind auf Anfrage erhältlich | упаковка предоставляется по запросу

REVIVE CONCRETE

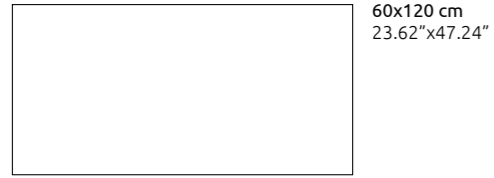

60x120 cm
23.62"x47.24"

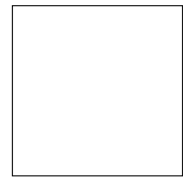

60x60 cm
23.62"x23.62"

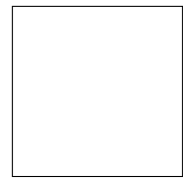

60x60 cm
23.62"x23.62"
20 mm
0.78"



30x60 cm
11.81"x23.62"

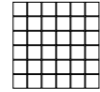

Mosaic 5x5
30x30 cm
11.81"x11.81"

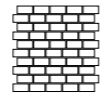

Mosaic 3x6
30x30 cm
11.81"x11.81"



Skirting
120x10 cm
47.24"x3.93"

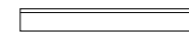

Skirting
60x8 cm
23.62"x3.14"

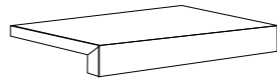

Step
30x120 cm
11.81"x47.24"
Front Sticking

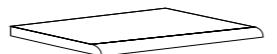

Step
30x120 cm
11.81"x47.24"
Bullnozed

REVIVE CONCRETE ACTIVE WHITE



REVIVE CONCRETE CONCRETE GREY



REVIVE CONCRETE GRAPHITE GREY

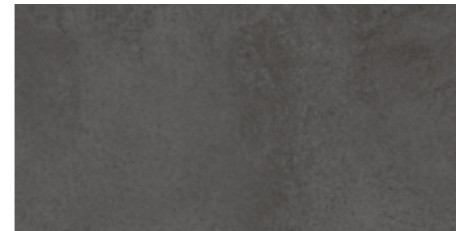

REVIVE CONCRETE CLOUD GREY



FINISHES

NATURAL



NATURAL

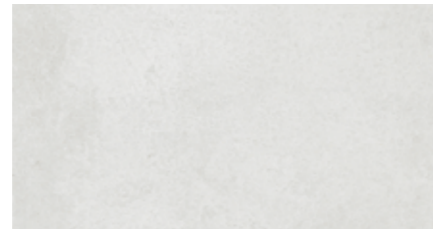

LAPPATO

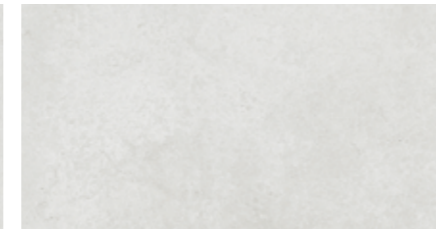

REVIVE CONCRETE PITCH BLACK



REVIVE CONCRETE SUMMER SAND



REVIVE CONCRETE



REVIVE CONCRETE
ACTIVE WHITE
MOSAIC 5X5 *

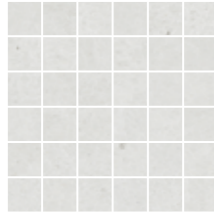

30X30 CM / 11.81"X11.81"

REVIVE CONCRETE MIX 1
MOSAIC 3X6

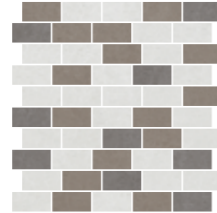

30X30 CM / 11.81"X11.81"

REVIVE CONCRETE MIX 2
MOSAIC 3X6

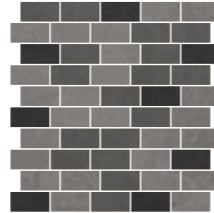

30X30 CM / 11.81"X11.81"

* Available in all colours | Disponibile in tutti i colori | Disponible dans toutes les couleurs | In allen Farben erhältlich | Disponible en todos los colores |
Доступно во всех цветах

PACKAGING | IMBALLI | EMBALLAGES | VERPAKUNGEN | УПАКОВКА

Sizes (cm)	Thickness (mm)	Pz X	M ² X	Kg X	RM X	X Sq. Pallet	M ² X Sq. Pallet	kg X Sq. Pallet	X Eu. Pallet	M ² X Eu. Pallet	kg X Eu. Pallet
60X120	9	2	1.44	30.00	-	-	-	-	30	43.20	921.00
60X60	9	4	1.44	30.00	-	-	-	-	30	43.20	921.00
60X60	20.00	2	0.72	32.00	-	-	-	-	30	21.60	1,000.00
30X60	9	6	1.08	23.00	-	-	-	-	48	51.84	1125.00
STEP 30X120	9	2	0.72	20	-	-	-	-	-	-	-
SKIRTING 120X10	9	12	1.44	34.8	-	-	-	-	33	47.52	1148.4
SKIRTING 70X8	9	10	-	14.40	7.5	-	-	-	66	-	950.00
SKIRTING 60X8	9	18	0.9	21	10.8	64.00	57.6	1,344.00	-	-	-
MOSAIC 30X30	9	10	-	14	-	48.00	-	-	48	-	672.00

WALL: REVIVE CONCRETE CLOUD GREY 30X60 CM,
REVIVE CONCRETE CLOUD GREY MOSAIC 5X5 30X30 CM
FLOOR: REVIVE CONCRETE CLOUD GREY 60X60 CM



REVIVE CONCRETE

FLOOR: REVIVE CONCRETE GRAPHITE GREY
60X60 CM (20MM THICKNESS)



Name	Code	Size(CM)	Code	Size(CM)	Code	Size(CM)
REVIVE CONCRETE ACTIVE WHITE	A12GZRCC-AWH.M2S5R	60x120	A06GZRCC-AWH.M2R	60x60	A06GZRCC-AWH.M2T5R	60x60
REVIVE CONCRETE CONCRETE GREY	AGB12REVCCRGZMLS5R	60x120	A06GZRCC-CCG.M2R	60x60	A06GZRCC-CCG.M2T5R	60x60
REVIVE CONCRETE GRAPHITE GREY	AGB12REVCGPGZMLS5R	60x120	A06GZRCC-GGY.M2R	60x60	A06GZRCC-GGY.M2T5R	60x60
REVIVE CONCRETE CLOUD GREY	AGB12REVCCGYZMLS5R	60x120	A06GZRCC-CDG.M2R	60x60	A06GZRCC-CDG.M2T5R	60x60
REVIVE CONCRETE PITCH BLACK	AGB12REVCPBKZMLS5R	60x120	A06GZRCC-PTB.M2R	60x60	A06GZRCC-PTB.M2T5R	60x60
REVIVE CONCRETE SUMMER SAND	AGB12REVCSMSZMLS5R	60x120	A06GZRCC-SSN.M2R	60x60	A06GZRCC-SSN.M2T5R	60x60

Name	Code	Size(CM)
REVIVE CONCRETE ACTIVE WHITE	A09GZRCC#AWH.M2R	30x60
REVIVE CONCRETE CONCRETE GREY	A09GZRCC#CCG.M2R	30x60
REVIVE CONCRETE GRAPHITE GREY	A09GZRCC#GGY.M2R	30x60
REVIVE CONCRETE CLOUD GREY	A09GZRCC#CDG.M2R	30x60
REVIVE CONCRETE PITCH BLACK	A09GZRCC#PTB.M2R	30x60
REVIVE CONCRETE SUMMER SAND	A09GZRCC#SSN.M2R	30x60

Name	Code	Size(CM)
REVIVE CONCRETE ACTIVE WHITE MOSAIC 5X5	AGM84REVCACWZMLNLR	30x30
REVIVE CONCRETE CONCRETE GREY MOSAIC 5X5	AGM84REVCCRGZMLNLR	30x30
REVIVE CONCRETE GRAPHITE GREY MOSAIC 5X5	AGM84REVCGPGZMLNLR	30x30
REVIVE CONCRETE CLOUD GREY MOSAIC 5X5	AGM84REVCCGYZMLNLR	30x30
REVIVE CONCRETE PITCH BLACK MOSAIC 5X5	AGM84REVCPBKZMLNLR	30x30
REVIVE CONCRETE SUMMER SAND MOSAIC 5X5	AGM84REVCSMSZMLNLR	30x30

REVIVE CONCRETE MIX 1 MOSAIC 3X6	AGM85REVCMX1ZMLNLR	30x30
REVIVE CONCRETE MIX 2 MOSAIC 3X6	AGM85REVCMX2ZMLNLR	30x30

Name	Code (Front Sticking)	Size(CM)	Code (Bullnozed)	Size(CM)
REVIVE CONCRETE ACTIVE WHITE STEP	AGTREVACW000272	30x120	AGTREVACW000279	30x120
REVIVE CONCRETE CONCRETE GREY STEP	AGTREVCCRG000276	30x120	AGTREVCCRG000283	30x120
REVIVE CONCRETE GRAPHITE GREY STEP	AGTREVCGPG000271	30x120	AGTREVCGPG000278	30x120
REVIVE CONCRETE CLOUD GREY STEP	AGTREVCCGY000275	30x120	AGTREVCCGY000282	30x120
REVIVE CONCRETE PITCH BLACK STEP	AGTREVCPBK000274	30x120	AGTREVCPBK000281	30x120
REVIVE CONCRETE SUMMER SAND STEP	AGTREVCSMS000277	30x120	AGTREVCSMS000284	30x120

Name	Code	Size(CM)	Code	Size(CM)
REVIVE CONCRETE ACTIVE WHITE SKIRTING	AGSREVCACW000266	120x10	AGSREVCACW000259	60x8
REVIVE CONCRETE CONCRETE GREY SKIRTING	AGSREVCCRG000270	120x10	AGSREVCCRG000263	60x8
REVIVE CONCRETE GRAPHITE GREY SKIRTING	AGSREVCGPG000265	120x10	AGSREVCGPG000258	60x8
REVIVE CONCRETE CLOUD GREY SKIRTING	AGSREVCCGY000269	120x10	AGSREVCCGY000262	60x8
REVIVE CONCRETE PITCH BLACK SKIRTING	AGSREVCPBK000268	120x10	AGSREVCPBK000261	60x8
REVIVE CONCRETE SUMMER SAND SKIRTING	AGSREVCSMS000271	120x10	AGSREVCSMS000264	60x8



REVIVE CONCRETE



Name	Code	Size(CM)	Code	Size(CM)	Code	Size(CM)
REVIVE CONCRETE ACTIVE WHITE	AGB12REVCACWZMSS5R	60x120	-	-	-	-
REVIVE CONCRETE CONCRETE GREY	-	-	-	-	AGB09REVCCRGZMSNLR	30x60
REVIVE CONCRETE GRAPHITE GREY	-	-	-	-	AGB09REVCCPGZMSNLR	30x60
REVIVE CONCRETE CLOUD GREY	-	-	-	-	-	-
REVIVE CONCRETE PITCH BLACK	AGB12REVCPBKZMSS5R	60x120	AGB06REVCPBKZMSNLR	60x60	AGB09REVCPBKZMSNLR	30x60
REVIVE CONCRETE SUMMER SAND	AGB12REVCSMSZMSS5R	60x120	AGB06REVCSMSZMSNLR	60x60	AGB09REVCSMSZMSNLR	30x60

Name	Code	Size(CM)
REVIVE CONCRETE ACTIVE WHITE MOSAIC 5X5	AGM84REVCACWZMSNLR	30x30
REVIVE CONCRETE CONCRETE GREY MOSAIC 5X5	AGM84REVCCRGZMSNLR	30x30
REVIVE CONCRETE GRAPHITE GREY MOSAIC 5X5	AGM84REVCCPGZMSNLR	30x30
REVIVE CONCRETE CLOUD GREY MOSAIC 5X5	AGM84REVCCGYZMSNLR	30x30
REVIVE CONCRETE PITCH BLACK MOSAIC 5X5	AGM84REVCPBKZMSNLR	30x30
REVIVE CONCRETE SUMMER SAND MOSAIC 5X5	AGM84REVCSMSZMSNLR	30x30

REVIVE CONCRETE MIX 1 MOSAIC 3X6	AGM85REVCMX1ZMSNLR	30x30
REVIVE CONCRETE MIX 2 MOSAIC 3X6	AGM85REVCMX2ZMSNLR	30x30

Name	Code (Front Sticking)	Size(CM)	Code (Bullnozed)	Size(CM)
REVIVE CONCRETE ACTIVE WHITE STEP	AGTREVACW001991	30x120	AGTREVACW001998	30x120
REVIVE CONCRETE CONCRETE GREY STEP	AGTREVCCRG001992	30x120	AGTREVCCRG001999	30x120
REVIVE CONCRETE GRAPHITE GREY STEP	AGTREVCCPG001993	30x120	AGTREVCCPG002000	30x120
REVIVE CONCRETE CLOUD GREY STEP	AGTREVCCGY001994	30x120	AGTREVCCGY002001	30x120
REVIVE CONCRETE PITCH BLACK STEP	AGTREVCPBK001995	30x120	AGTREVCPBK002002	30x120
REVIVE CONCRETE SUMMER SAND STEP	AGTREVCSMS001996	30x120	AGTREVCSMS002003	30x120

Name	Code	Size(CM)	Code	Size(CM)
REVIVE CONCRETE ACTIVE WHITE SKIRTING	AGSREVACW001965	120x10	AGSREVACW001952	60x8
REVIVE CONCRETE CONCRETE GREY SKIRTING	AGSREVCCRG001969	120x10	AGSREVCCRG001956	60x8
REVIVE CONCRETE GRAPHITE GREY SKIRTING	AGSREVCCPG001964	120x10	AGSREVCCPG001951	60x8
REVIVE CONCRETE CLOUD GREY SKIRTING	AGSREVCCGY001968	120x10	AGSREVCCGY001955	60x8
REVIVE CONCRETE PITCH BLACK SKIRTING	AGSREVCPBK001967	120x10	AGSREVCPBK001954	60x8
REVIVE CONCRETE SUMMER SAND SKIRTING	AGSREVCSMS001970	120x10	AGSREVCSMS001957	60x8



Name	Code	Size(CM)	Code	Size(CM)	Code	Size(CM)
REVIVE CONCRETE ACTIVE WHITE	AGB12REVCACWZMLS5L	60x120	A06GZRCC-AWH.M2L	60x60	A09GZRCC#AWH.M2L	30x60
REVIVE CONCRETE CONCRETE GREY	AGB12REVCCRGZMLS5L	60x120	A06GZRCC-CCG.M2L	60x60	-	-
REVIVE CONCRETE GRAPHITE GREY	AGB12REVCCPGZMLS5L	60x120	A06GZRCC-GGY.M2L	60x60	-	-
REVIVE CONCRETE CLOUD GREY	AGB12REVCCGYZMLS5L	60x120	A06GZRCC-CDG.M2L	60x60	A09GZRCC#CDG.M2L	30x60
REVIVE CONCRETE PITCH BLACK	AGB12REVCPBKZMLS5L	60x120	A06GZRCC-PTB.M2L	60x60	-	-
REVIVE CONCRETE SUMMER SAND	AGB12REVCSMSZMLS5L	60x120	A06GZRCC-SSN.M2L	60x60	-	-

Name	Code	Size(CM)
REVIVE CONCRETE ACTIVE WHITE MOSAIC 5X5	AGM84REVCACWZMLNLV	30x30
REVIVE CONCRETE CONCRETE GREY MOSAIC 5X5	AGM84REVCCRGZMLNLV	30x30
REVIVE CONCRETE GRAPHITE GREY MOSAIC 5X5	AGM84REVCCPGZMLNLV	30x30
REVIVE CONCRETE CLOUD GREY MOSAIC 5X5	AGM84REVCCGYZMLNLV	30x30
REVIVE CONCRETE PITCH BLACK MOSAIC 5X5	AGM84REVCPBKZMLNLV	30x30
REVIVE CONCRETE SUMMER SAND MOSAIC 5X5	AGM84REVCSMSZMLNLV	30x30

REVIVE CONCRETE MIX 1 MOSAIC 3X6	AGM85REVCMX1ZMLNLV	30x30
REVIVE CONCRETE MIX 2 MOSAIC 3X6	AGM85REVCMX2ZMLNLV	30x30

Name	Code (Front Sticking)	Size(CM)	Code (Bullnozed)	Size(CM)
REVIVE CONCRETE ACTIVE WHITE STEP	AGTREVACW002005	30x120	AGTREVACW002012	30x120
REVIVE CONCRETE CONCRETE GREY STEP	AGTREVCCRG002006	30x120	AGTREVCCRG002013	30x120
REVIVE CONCRETE GRAPHITE GREY STEP	AGTREVCCPG002007	30x120	AGTREVCCPG002014	30x120
REVIVE CONCRETE CLOUD GREY STEP	AGTREVCCGY002008	30x120	AGTREVCCGY002015	30x120
REVIVE CONCRETE PITCH BLACK STEP	AGTREVCPBK002009	30x120	AGTREVCPBK002016	30x120
REVIVE CONCRETE SUMMER SAND STEP	AGTREVCSMS002010	30x120	AGTREVCSMS002017	30x120

Name	Code	Size(CM)	Code	Size(CM)
REVIVE CONCRETE ACTIVE WHITE SKIRTING	AGSREVACW001985	120x10	AGSREVACW001972	60x8
REVIVE CONCRETE CONCRETE GREY SKIRTING	AGSREVCCRG001989	120x10	AGSREVCCRG001976	60x8
REVIVE CONCRETE GRAPHITE GREY SKIRTING	AGSREVCCPG001984	120x10	AGSREVCCPG001971	60x8
REVIVE CONCRETE CLOUD GREY SKIRTING	AGSREVCCGY001988	120x10	AGSREVCCGY001975	60x8
REVIVE CONCRETE PITCH BLACK SKIRTING	AGSREVCPBK001987	120x10	AGSREVCPBK001974	60x8
REVIVE CONCRETE SUMMER SAND SKIRTING	AGSREVCSMS001990	120x10	AGSREVCSMS001977	60x8

Name	Code	Size(CM)	Code	Size(CM)	Code	Size(CM)
REVIVE CONCRETE ACTIVE WHITE	AGB09REVCACWZMSNLL	30x60	-	-	A06GZRCC-AWH.M2F	60x60
REVIVE CONCRETE CONCRETE GREY	AGB09REVCCRGZMSNLL	30x60	AGB12ZRCCGRYSLS9F	60x120	A06GZRCC-CCG.M2F	60x60
REVIVE CONCRETE GRAPHITE GREY	AGB09REVCCPGZMSNLL	30x60	-	-	A06GZRCC-GGY.M2F	60x60
REVIVE CONCRETE CLOUD GREY	-	-	A09GZRCC#CDG.M2F	30x60	A06GZRCC-CDG.M2F	60x60
REVIVE CONCRETE PITCH BLACK	AGB09REVCPBKZMSNLL	30x60	-	-	-	-
REVIVE CONCRETE SUMMER SAND	AGB09REVCSMSZMSNLL	30x60	-	-	-	-

SIGNATURE
COLLECTION

STONE
& METAL

FLOOR: CORAL STONE BEIGE 60X60 CM



CORAL STONE



WALL: CORAL STONE LIGHT GREY 60X60 CM,
CORAL STONE DARK GREY 60X60 CM.
FLOOR: CORAL STONE BEIGE 60X60 CM



CORAL STONE

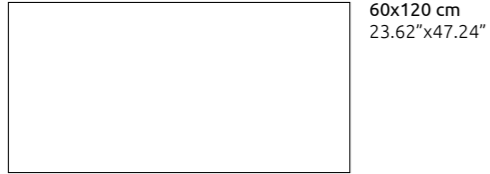

60x120 cm
23.62"x47.24"

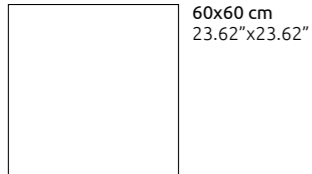

60x60 cm
23.62"x23.62"

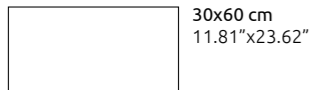

30x60 cm
11.81"x23.62"

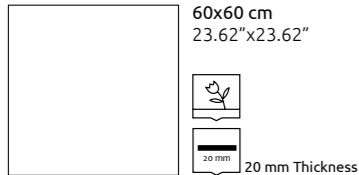

60x60 cm
23.62"x23.62"



20 mm Thickness

Klima is a new generation ceramic that, thanks to special materials, is able to absorb and repel heat according to individual needs. Suitable for both indoor and outdoor applications, for flooring or external walls, to achieve maximum comfort with minimum energy impact.

CORAL STONE LIGHT GREY



CORAL STONE GREY



Name	Code	Size(CM)	Code	Size(CM)	Code	Size(CM)
CORAL STONE LIGHT GREY	A12GCLNA-LGY.A6X5R	60x120	A06GCLNA-LGY.A6X0R	60x60	A06GCLNA-LGY.A6X7R	60x60
CORAL STONE GREY	A12GCLNA-GRY.A6X5R	60x120	A06GCLNA-GRY.A6X0R	60x60	A06GCLNA-GRY.A6X7R	60x60
CORAL STONE IVORY	A12GCLNA-IVO.A6X5R	60x120	A06GCLNA-IVO.A6X0R	60x60	A06GCLNA-IVO.A6X7R	60x60
CORAL STONE BEIGE	A12GCLNA-BEE.A6X5R	60x120	A06GCLNA-BEE.A6X0R	60x60	A06GCLNA-BEE.A6X7R	60x60
CORAL STONE LIGHT GREY	A09GCLNA-LGY.A6X0R	30x60				
CORAL STONE GREY	A09GCLNA-GRY.A6X0R	30x60				
CORAL STONE IVORY	A09GCLNA-IVO.A6X0R	30x60				
CORAL STONE BEIGE	A09GCLNA-BEE.A6X0R	30x60				

PACKAGING | IMBALLI | EMBALLAGES | VERPAKUNGEN | УПАКОВКА

Sizes (cm)	Thickness (mm)	Pz X	M² X	Kg X	X Eu. Pallet	M² X Eu. Pallet	kg X Eu. Pallet
60x120	9	2	1.44	30.00	30	43.20	921.00
60x60	9	4	1.44	30.00	30	43.20	921.00
30x60	9	6	1.08	23.00	48	51.84	1125.00
60x60	20	2	0.72	32.00	30	21.60	1000.00

CORAL STONE IVORY



CORAL STONE BEIGE



WALL: FLAG STONE LIGHT SAND 60X120 CM



FLAG STONE

WALL: FLAG STONE LIGHT GREY 60X120 CM
FLOOR: FLAG STONE LIGHT GREY 60X120 CM



WALL: FLAG STONE LIGHT SAND 60X120 CM
FLOOR: FLAG STONE SAND 60X120 CM



FLAG STONE

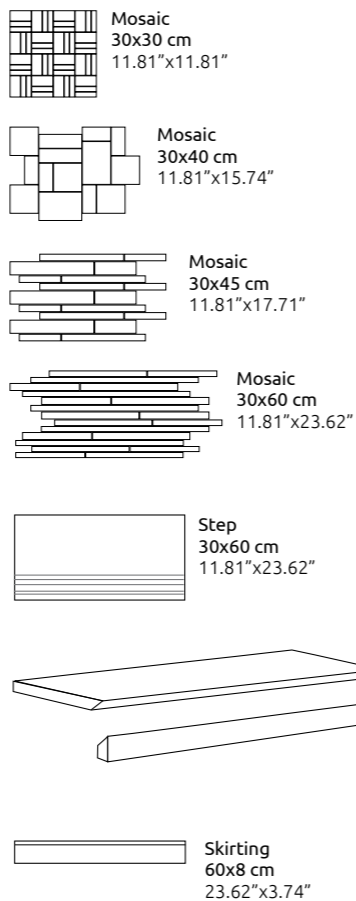
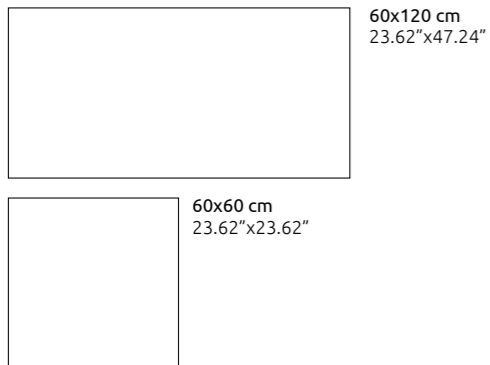

FLAG STONE WHITE



FLAG STONE LIGHT GREY



FLAG STONE GRAPHITE GREY



FLAG STONE LIGHT SAND



FLAG STONE SAND







Klima is a new generation ceramic that, thanks to special materials, is able to absorb and repel heat according to individual needs. Suitable for both indoor and outdoor applications, for flooring or external walls, to achieve maximum comfort with minimum energy impact.



COLD



WARM



ENERGY SAVING

FLAG STONE



FLAG STONE
MOSAIC*



30X30 CM / 11.81"X11.81"

FLAG STONE
MOSAIC 30x40*



30X40 CM / 11.81"X15.74"

FLAG STONE
MOSAIC 30x45*



30X45 CM / 11.81"X17.71"

FLAG STONE
MOSAIC 30x60*



30X60 CM / 11.81"X23.62"

*Available in all colours | Disponibile in tutti i colori | Disponible dans toutes les couleurs | In allen Farben erhältlich | Disponible en todos los colores | Доступно во всех цветах

PACKAGING | IMBALLI | EMBALLAGES | VERPAKUNGEN | УПАКОВКА

Sizes (cm)	Thickness (mm)	Pz X	M ² X	Kg X	RM X	X Sq. Pallet	M ² X Sq. Pallet	kg X Sq. Pallet	X Eu. Pallet	M ² X Eu. Pallet	kg X Eu. Pallet
60x120	9	2	1.44	30.00	-	-	-	-	30	43.20	921.00
60x60	9	4	1.44	30.00	-	-	-	-	30	43.20	921.00
MOSAIC 30x30	9	10	-	14.00	-	-	-	-	48	-	672.00
MOSAIC 30x40	9	8	-	13.00	-	-	-	-	48	-	624.00
MOSAIC 30x45	9	6	-	15.00	-	-	-	-	30	-	450.00
MOSAIC 30X60	9	6	-	17.00	-	-	-	-	30	-	510.00
STEPS 30x120	9	2	0.72	20.00	-	-	-	-	-	-	-
STEPS 30x60	9	6	-	18.00	-	-	-	-	48	-	900.00
SKIRTING 75x8	9	10	-	14.40	7.5	-	-	-	66	-	950.40
SKIRTING 60x8	9	18	-	19.00	-	80	-	1520.00	-	-	-

Name	Code	Size(CM)	Code	Size(CM)
FLAG STONE WHITE	A12GFGSN-WHE.M6X5R	60X120	A06GFGSN-WHE.M6X0R	60X60
FLAG STONE LIGHT GREY	A12GFGSN-LIG.M6X5R	60X120	A06GFGSN-LIG.M6X0R	60X60
FLAG STONE GRAPHITE GREY	A12GFGSN-GPG.M6X5R	60X120	A06GFGSN-GPG.M6X0R	60X60
FLAG STONE LIGHT SAND	A12GFGSN-LHS.M6X5R	60X120	A06GFGSN-LHS.M6X0R	60X60
FLAG STONE SAND	A12GFGSN-SND.M6X5R	60X120	A06GFGSN-SND.M6X0R	60X60

Name	Code	Size(CM)	Name	Code	Size(CM)
FLAG STONE WHITE MOSAIC 30X30	AGMZZFGSNWHE008620	30X30	FLAG STONE WHITE MOSAIC 30X40	AGMZZFGSNWHE008552	30X40
FLAG STONE LIGHT GREY MOSAIC 30X30	AGMZZFGSNLIG008617	30X30	FLAG STONE LIGHT GREY MOSAIC 30X40	AGMZZFGSNLIG008549	30X40
FLAG STONE GRAPHITE GREY MOSAIC 30X30	AGMZZFGSNGPG008616	30X30	FLAG STONE GRAPHITE GREY MOSAIC 30X40	AGMZZFGSNGPG008548	30X40
FLAG STONE LIGHT SAND MOSAIC 30X30	AGMZZFGSNLHS008618	30X30	FLAG STONE LIGHT SAND MOSAIC 30X40	AGMZZFGSNLHS008550	30X40
FLAG STONE SAND MOSAIC 30X30	AGMZZFGSNSND008619	30X30	FLAG STONE SAND MOSAIC 30X40	AGMZZFGSNSND008551	30X40

FLAG STONE WHITE MOSAIC 30X45	AGMZZFGSNWHE008444	30X45	FLAG STONE WHITE MOSAIC 30X60	AGMZZFGSNWHE008165	30X60
FLAG STONE LIGHT GREY MOSAIC 30X45	AGMZZFGSNLIG008441	30X45	FLAG STONE LIGHT GREY MOSAIC 30X60	AGMZZFGSNLIG008162	30X60
FLAG STONE GRAPHITE GREY MOSAIC 30X45	AGMZZFGSNGPG008440	30X45	FLAG STONE GRAPHITE GREY MOSAIC 30X60	AGMZZFGSNGPG008161	30X60
FLAG STONE LIGHT SAND MOSAIC 30X45	AGMZZFGSNLHS008442	30X45	FLAG STONE LIGHT SAND MOSAIC 30X60	AGMZZFGSNLHS008163	30X60
FLAG STONE SAND MOSAIC 30X45	AGMZZFGSNSND008443	30X45	FLAG STONE SAND MOSAIC 30X60	AGMZZFGSNSND008164	30X60

FLAG STONE WHITE SKIRTING	AGSZZFGSNWHE009721	60X8	FLAG STONE WHITE STEP	AGTZZFGSNWHE017821	30X60
FLAG STONE LIGHT GREY SKIRTING	AGSZZFGSNLHS009719	60X8	FLAG STONE LIGHT GREY STEP	AGTZZFGSNLIG017818	30X60
FLAG STONE GRAPHITE GREY SKIRTING	AGSZZFGSNGPG009717	60X8	FLAG STONE GRAPHITE GREY STEP	AGMZZFGSNGPG017817	30X60
FLAG STONE LIGHT SAND SKIRTING	AGSZZFGSNLIG009718	60X8	FLAG STONE LIGHT SAND STEP	AGTZZFGSNLHS017819	30X60
FLAG STONE SAND SKIRTING	AGSZZFGSNSND009720	60X8	FLAG STONE SAND STEP	AGTZZFGSNSND017820	30X60

FLAG STONE WHITE STEP	AGTZZFGSNWHE009417	30X120	FLAG STONE WHITE RISER	AGRZZFGSNWHE009422	5X120
FLAG STONE LIGHT GREY STEP	AGTZZFGSNLIG009415	30X120	FLAG STONE LIGHT GREY RISER	AGRZZFGSNLIG009420	5X120
FLAG STONE GRAPHITE GREY STEP	AGTZZFGSNGPG009413	30X120	FLAG STONE GRAPHITE GREY RISER	AGRZZFGSNGPG009418	5X120
FLAG STONE LIGHT SAND STEP	AGTZZFGSNLHS009414	30X120	FLAG STONE LIGHT SAND RISER	AGRZZFGSNLHS009419	5X120
FLAG STONE SAND STEP	AGTZZFGSNSND009416	30X120	FLAG STONE SAND RISER	AGRZZFGSNSND009421	5X120

WALL: K-ROCK GREY 60X120 CM,
FLOOR: K-ROCK LIGHT GREY 60X60 CM



K-ROCK

WALL: K-ROCK LIGHT GREY 60X120 CM,
FLOOR: K-ROCK LIGHT GREY 60X60 CM



WALL: K-ROCK LIGHT GREY 60X120 CM,
FLOOR: K-ROCK LIGHT GREY 60X60 CM



K-ROCK

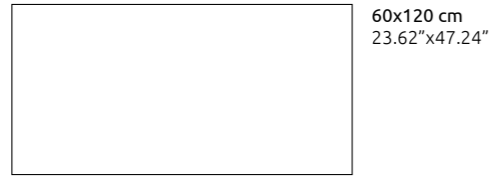

60x120 cm
23.62"x47.24"

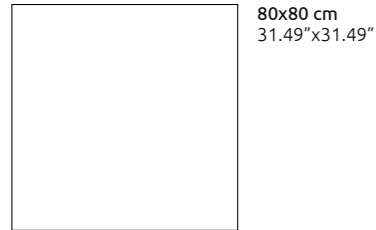

80x80 cm
31.49"x31.49"

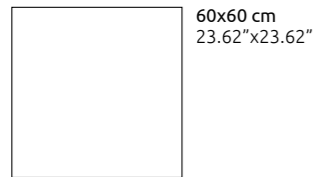

60x60 cm
23.62"x23.62"



Skirting
60x8 cm
23.62"x3.14"

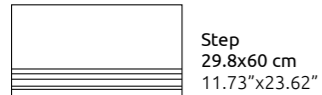

Step
29.8x60 cm
11.73"x23.62"



Step
30x120 cm
11.81"x47.24"

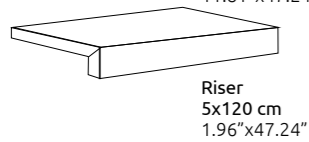

Riser
5x120 cm
1.96"x47.24"

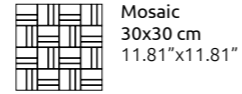

Mosaic
30x30 cm
11.81"x11.81"

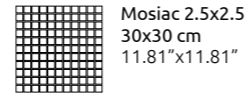

Mosaic 2.5x2.5
30x30 cm
11.81"x11.81"

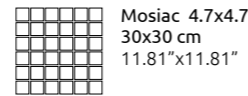

Mosaic 4.7x4.7
30x30 cm
11.81"x11.81"

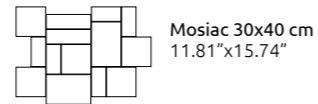

Mosaic 30x40 cm
11.81"x15.74"



Mosaic 30x45 cm
11.81"x17.71"

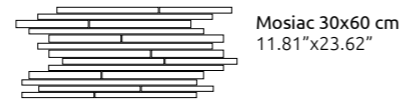

Mosaic 30x60 cm
11.81"x23.62"

K-ROCK WHITE



K-ROCK GREY



K-ROCK LIGHT GREY



K-ROCK IVORY



K-ROCK DARK GREY



K-ROCK BROWN



K-ROCK BEIGE



K-ROCK

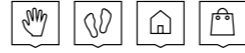

K-ROCK
MOSAIC 2.5X2.5*

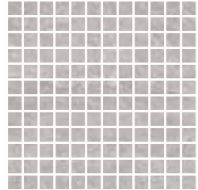

30X30 CM / 11.81"x11.81"

K-ROCK
MOSAIC 4.7X4.7*



30X30 CM / 11.81"x11.81"

K-ROCK
MOSAIC*

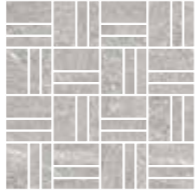

30X30 CM / 11.81"x11.81"

K-ROCK
MOSAIC 30x40*

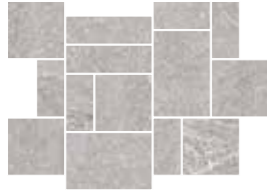

30X40 CM / 11.81"x15.74"

K-ROCK
MOSAIC 30x45*



30X45 CM / 11.81"x17.71"

K-ROCK
MOSAIC 30x60*



30X60 CM / 11.81"x23.62"

*Available in all colours | Disponibile in tutti i colori | Disponible dans toutes les couleurs | In allen Farben erhältlich | Disponible en todos los colores | Доступно во всех цветах

PACKAGING | IMBALLI | EMBALLAGES | VERPAKUNGEN | УПАКОВКА

Sizes (cm)	Thickness (mm)	Pz X	M² X	Kg X	RM X	Sq. Pallet	M² X Sq. Pallet	kg X Sq. Pallet	Eu. Pallet	M² X Eu. Pallet	kg X Eu. Pallet
80x80	9	3	1.92	40.00	-	-	-	-	30	57.60	1221.00
60x120	9	2	1.44	30.00	-	-	-	-	30	43.20	921.00
60x60	9	4	1.44	30.00	-	-	-	-	30	43.20	921.00
MOSAIC 30x30	9	10	-	14.00	-	-	-	-	48	-	672.00
MOSAIC 30x40	9	8	-	13.00	-	-	-	-	48	-	624.00
MOSAIC 30x45	9	6	-	15.00	-	-	-	-	30	-	450.00
MOSAIC 30x60	9	6	-	17.00	-	-	-	-	30	-	510.00
STEPS 30x120	9	2	0.72	20.00	-	-	-	-	-	-	-
STEPS 29.8x60	9	6	-	18.00	-	-	-	-	48	-	900.00
SKIRTING 60x8	9	18	-	19.00	-	80	-	1520.00	-	-	-

Name	Code	Size(CM)	Code	Size(CM)	Code	Size(CM)
K-ROCK WHITE	A12GKRCK-WHE.M6X5R	60x120	A06GKRCK-WHE.M6X0R	60x60	A05GKRCK-WHE.M6X0R	80x80
K-ROCK LIGHT GREY	A12GKRCK-LIG.M6X5R	60x120	A06GKRCK-LIG.M6X0R	60x60	A05GKRCK-LIG.M6X0R	80x80
K-ROCK GREY	A12GKRCK-GRY.M6X5R	60x120	A06GKRCK-GRY.M6X0R	60x60	A05GKRCK-GRY.M6X0R	80x80
K-ROCK ANTHRACITE	A12GKRCK-ANT.M6X5R	60x120	A06GKRCK-ANT.M6X0R	60x60	A05GKRCK-ANT.M6X0R	80x80
K-ROCK IVORY	A12GKRCK-IVO.M6X5R	60x120	A06GKRCK-IVO.M6X0R	60x60	A05GKRCK-IVO.M6X0R	80x80
K-ROCK BEIGE	A12GKRCK-BEE.M6X5R	60x120	A06GKRCK-BEE.M6X0R	60x60	A05GKRCK-BEE.M6X0R	80x80
K-ROCK BROWN	A12GKRCK-BRN.M6X5R	60x120	A06GKRCK-BRN.M6X0R	60x60	A05GKRCK-BRN.M6X0R	80x80

Name	Code	Size(CM)	Name	Code	Size(CM)
K-ROCK WHITE MOSAIC 2.5X2.5	AGMZZKRCKWHE030472	30x30	K-ROCK WHITE MOSAIC 4.7X4.7	AGMZZKRCKWHE030427	30x30
K-ROCK LIGHT GREY MOSAIC 2.5X2.5	AGMZZKRCKLIG030471	30x30	K-ROCK LIGHT GREY MOSAIC 4.7X4.7	AGMZZKRCKLIG030426	30x30
K-ROCK GREY MOSAIC 2.5X2.5	AGMZZKRCKGRY030469	30x30	K-ROCK GREY MOSAIC 4.7X4.7	AGMZZKRCKGRY030424	30x30
K-ROCK ANTHRACITE MOSAIC 2.5X2.5	AGMZZKRCKANT030470	30x30	K-ROCK ANTHRACITE MOSAIC 4.7X4.7	AGMZZKRCKANT030425	30x30
K-ROCK IVORY MOSAIC 2.5X2.5	AGMZZKRCKIVO030473	30x30	K-ROCK IVORY MOSAIC 4.7X4.7	AGMZZKRCKIVO030428	30x30
K-ROCK BEIGE MOSAIC 2.5X2.5	AGMZZKRCKBEE030467	30x30	K-ROCK BEIGE MOSAIC 4.7X4.7	AGMZZKRCKBEE030422	30x30
K-ROCK BROWN MOSAIC 2.5X2.5	AGMZZKRCKBRN030468	30x30	K-ROCK BROWN MOSAIC 4.7X4.7	AGMZZKRCKBRN030423	30x30

K-ROCK WHITE MOSAIC 30X30	AGMZZKRCKWHE030520	30x30	K-ROCK WHITE MOSAIC 30X40	AGMZZKRCKWHE030571	30x40
K-ROCK LIGHT GREY MOSAIC 30X30	AGMZZKRCKLIG030519	30x30	K-ROCK LIGHT GREY MOSAIC 30X40	AGMZZKRCKLIG030570	30x40
K-ROCK GREY MOSAIC 30X30	AGMZZKRCKGRY030517	30x30	K-ROCK GREY MOSAIC 30X40	AGMZZKRCKGRY030568	30x40
K-ROCK ANTHRACITE MOSAIC 30X30	AGMZZKRCKANT030518	30x30	K-ROCK ANTHRACITE MOSAIC 30X40	AGMZZKRCKANT030569	30x40
K-ROCK IVORY MOSAIC 30X30	AGMZZKRCKIVO030521	30x30	K-ROCK IVORY MOSAIC 30X40	AGMZZKRCKIVO030572	30x40
K-ROCK BEIGE MOSAIC 30X30	AGMZZKRCKBEE030515	30x30	K-ROCK BEIGE MOSAIC 30X40	AGMZZKRCKBEE030566	30x40
K-ROCK BROWN MOSAIC 30X30	AGMZZKRCKBRN030516	30x30	K-ROCK BROWN MOSAIC 30X40	AGMZZKRCKBRN030567	30x40

K-ROCK WHITE MOSAIC	AGMZZKRCKWHE030633	30x45	K-ROCK WHITE MOSAIC	AGMZZKRCKWHE030769	30x60
K-ROCK LIGHT GREY MOSAIC	AGMZZKRCKLIG030632	30x45	K-ROCK LIGHT GREY MOSAIC	AGMZZKRCKLIG030768	30x60
K-ROCK GREY MOSAIC	AGMZZKRCKGRY030630	30x45	K-ROCK GREY MOSAIC	AGMZZKRCKGRY030766	30x60
K-ROCK ANTHRACITE MOSAIC	AGMZZKRCKANT030631	30x45	K-ROCK ANTHRACITE MOSAIC	AGMZZKRCKANT030767	30x60
K-ROCK IVORY MOSAIC	AGMZZKRCKIVO030634	30x45	K-ROCK IVORY MOSAIC	AGMZZKRCKIVO030770	30x60
K-ROCK BEIGE MOSAIC	AGMZZKRCKBEE030628	30x45	K-ROCK BEIGE MOSAIC	AGMZZKRCKBEE030764	30x60
K-ROCK BROWN MOSAIC	AGMZZKRCKBRN030629	30x45	K-ROCK BROWN MOSAIC	AGMZZKRCKBRN030765	30x60

K-ROCK WHITE SKIRTING	AGSZZKRCKWHE031404	60x8	K-ROCK WHITE STEP	AGTZZKRCKWHE031887	29.8x60
K-ROCK LIGHT GREY SKIRTING	AGSZZKRCKLIG031403	60x8	K-ROCK LIGHT GREY STEP	AGTZZKRCKLIG031886	29.8x60
K-ROCK GREY SKIRTING	AGSZZKRCKGRY031401	60x8	K-ROCK GREY STEP	AGTZZKRCKGRY031884	29.8x60
K-ROCK ANTHRACITE SKIRTING	AGSZZKRCKANT031402	60x8	K-ROCK ANTHRACITE STEP	AGTZZKRCKANT031885	29.8x60
K-ROCK IVORY SKIRTING	AGSZZKRCKIVO031405	60x8	K-ROCK IVORY STEP	AGTZZKRCKIVO031888	29.8x60
K-ROCK BEIGE SKIRTING	AGSZZKRCKBEE031399	60x8	K-ROCK BEIGE STEP	AGTZZKRCKBEE031882	29.8x60
K-ROCK BROWN SKIRTING	AGSZZKRCKBRN031400	60x8	K-ROCK BROWN STEP	AGTZZKRCKBRN031883	29.8x60

K-ROCK WHITE STEP	AGTZZKRCKWHE030392	30x120	K-ROCK WHITE RISER	AGRZZKRCKWHE030366	5x120
K-ROCK LIGHT GREY STEP	AGTZZKRCKLIG030391	30x120	K-ROCK LIGHT GREY RISER	AGRZZKRCKLIG030365	5x120
K-ROCK GREY STEP	AGTZZKRCKGRY030389	30x120	K-ROCK GREY RISER	AGRZZKRCKGRY030363	5x120
K-ROCK ANTHRACITE STEP	AGTZZKRCKANT030390	30x120	K-ROCK ANTHRACITE RISER	AGRZZKRCKANT030364	5x120
K-ROCK IVORY STEP	AGTZZKRCKIVO030393	30x120	K-ROCK IVORY RISER	AGRZZKRCKIVO030367	5x120
K-ROCK BEIGE STEP	AGTZZKRCKBEE030387	30x120	K-ROCK BEIGE RISER	AGRZZKRCKBEE030361	5x120
K-ROCK BROWN STEP	AGTZZKRCKBRN030388	30x120	K-ROCK BROWN RISER	AGRZZKRCKBRN030362	5x120

FLOOR: MAREMMA DARK BROWN 75X75 CM



MAREMMA



WALL: MAREMMA GREY MOSAIC 29.5X29.5 CM
FLOOR: MAREMMA GREY 75X75 CM



MAREMMA

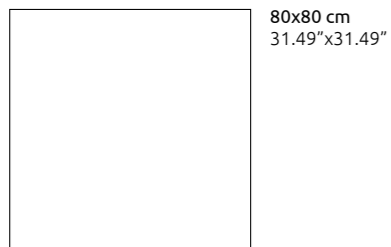

80x80 cm
31.49"x31.49"



60x120 cm
23.62"x47.24"

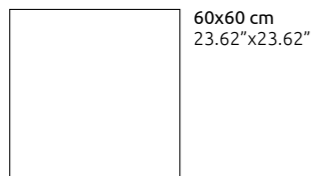

60x60 cm
23.62"x23.62"

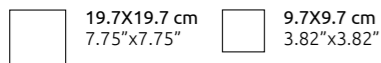

19.7X19.7 cm
7.75"x7.75"

9.7X9.7 cm
3.82"x3.82"

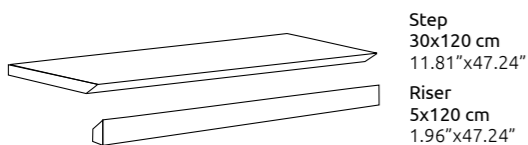

Step
30x120 cm
11.81"x47.24"

Riser
5x120 cm
1.96"x47.24"



Skirting
60x8 cm
23.62"x3.74"

MAREMMA STEEL



MAREMMA GREY



MAREMMA DARK BROWN



MAREMMA ORANGE

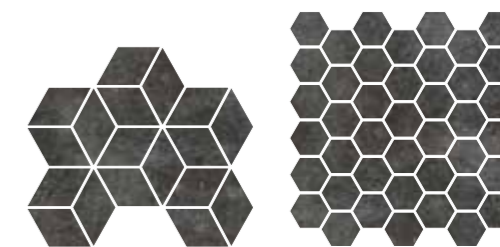

MAREMMA *
MOSAIC 25.5X29.5

MAREMMA *
MOSAIC 30X30

MAREMMA SAND



MAREMMA COPPER



MAREMMA COTTO



*Available in all colours | Disponibile in tutti i colori | Disponible dans toutes les couleurs | In allen Farben erhältlich | Disponible en todos los colores | Доступно во всех цветах

MAREMMA



Name	Code	Size(CM)	Code	Size(CM)	Code	Size(CM)	Code	Size(CM)
MAREMMA STEEL	AGB12MRMASTEZMLSSR	60X120	AGB06MRMASTEZMLNLR	60X60	A05GMRMA-STE.M6X0R	80x80	AGXZZMRMASTE006247	19.7x19.7
MAREMMA COPPER	AGB12MRMACOPZMLSSR	60X120	AGB06MRMACOPZMLNLR	60X60	A05GMRMA-COP.M6X0R	80x80	AGXZZMRMACOP006243	19.7x19.7
MAREMMA GREY	AGB12MRMAGRYZMLSSR	60X120	AGB06MRMAGRYZMLNLR	60X60	A05GMRMA-GRY.M6X0R	80x80	AGXZZMRMAGRY006248	19.7x19.7
MAREMMA SAND	AGB12MRMASNDZMLSSR	60X120	AGB06MRMASNDZMLNLR	60X60	A05GMRMA-SND.M6X0R	80x80	AGXZZMRMASND006246	19.7x19.7
MAREMMA DARK BROWN	AGB12MRMADBRZMLSSR	60X120	AGB06MRMADBRZMLNLR	60X60	A05GMRMA-DBR.M6X0R	80x80	AGXZZMRMADBR006244	19.7x19.7
MAREMMA ORANGE	AGB12MRMAOREZMLSSR	60X120	AGB06MRMAOREZMLNLR	60X60	A05GMRMA-ORE.M6X0R	80x80	AGXZZMRMAORE006245	19.7x19.7
MAREMMA COTTO	AGB12MRMACOTZMLSSR	60X120	AGB06MRMACOTZMLNLR	60X60	A05GMRMA-COT.M6X0R	80x80	AGXZZMRMACOT006249	19.7x19.7

Name	Code	Size(CM)	Name	Code	Size(CM)
MAREMMA STEEL	AGXZZMRMASTE006729	9.7x9.7	MAREMMA STEEL RISER	AGRZZMRMASTE005977	5X120
MAREMMA COPPER	AGXZZMRMACOP006723	9.7x9.7	MAREMMA COPPER RISER	AGRZZMRMACOP005971	5X120
MAREMMA GREY	AGXZZMRMAGRY006726	9.7x9.7	MAREMMA GREY RISER	AGRZZMRMAGRY005974	5X120
MAREMMA SAND	AGXZZMRMASND006728	9.7x9.7	MAREMMA SAND RISER	AGRZZMRMASND005976	5X120
MAREMMA DARK BROWN	AGXZZMRMADBR006725	9.7x9.7	MAREMMA DARK BROWN RISER	AGRZZMRMADBR005973	5X120
MAREMMA ORANGE	AGXZZMRMAORE006727	9.7x9.7	MAREMMA ORANGE RISER	AGRZZMRMAORE005975	5X120
MAREMMA COTTO	AGXZZMRMACOT006724	9.7x9.7	MAREMMA COTTO RISER	AGRZZMRMACOT005972	5X120

Name	Code	Size(CM)	Name	Code	Size(CM)
MAREMMA STEEL MOSAIC 30x30	AGWZZMRMASTE006642	30x30	MAREMMA STEEL MOSAIC 25.5X29.5	AGWZZMRMASTE005546	25.5X29.5
MAREMMA COPPER MOSAIC 30x30	AGWZZMRMACOP006636	30x30	MAREMMA COPPER 25.5X29.5	AGWZZMRMACOP005542	25.5X29.5
MAREMMA GREY MOSAIC 30x30	AGWZZMRMAGRY006638	30x30	MAREMMA GREY 25.5X29.5	AGWZZMRMAGRY005547	25.5X29.5
MAREMMA SAND MOSAIC 30x30	AGWZZMRMASND006641	30x30	MAREMMA SAND 25.5X29.5	AGWZZMRMASND005545	25.5X29.5
MAREMMA DARK BROWN MOSAIC 30x30	AGWZZMRMADBR006637	30x30	MAREMMA DARK BROWN 25.5X29.5	AGWZZMRMADBR005543	25.5X29.5
MAREMMA ORANGE MOSAIC 30x30	AGWZZMRMAORE006639	30x30	MAREMMA ORANGE 25.5X29.5	AGWZZMRMAORE005544	25.5X29.5
MAREMMA COTTO MOSAIC 30x30	AGWZZMRMACOT006634	30x30	MAREMMA COTTO 25.5X29.5	AGWZZMRMACOT005548	25.5X29.5

MAREMMA STEEL STEP	AGTZZMRMASTE005970	30X120	MAREMMA STEEL STEP	AGTZZMRMASTE005830	29.5X59.5
MAREMMA COPPER STEP	AGTZZMRMACOP005964	30X120	MAREMMA COPPER STEP	AGTZZMRMACOP005824	29.5X59.5
MAREMMA GREY STEP	AGTZZMRMAGRY005966	30X120	MAREMMA GREY STEP	AGTZZMRMAGRY005827	29.5X59.5
MAREMMA SAND STEP	AGTZZMRMASND005969	30X120	MAREMMA SAND STEP	AGTZZMRMASND005829	29.5X59.5
MAREMMA DARK BROWN STEP	AGTZZMRMADBR005965	30X120	MAREMMA DARK BROWN STEP	AGTZZMRMADBR005826	29.5X59.5
MAREMMA ORANGE STEP	AGTZZMRMAORE005968	30X120	MAREMMA ORANGE STEP	AGTZZMRMAORE005828	29.5X59.5
MAREMMA COTTO STEP	AGTZZMRMACOT005967	30X120	MAREMMA COTTO STEP	AGTZZMRMACOT005825	29.5X59.5

MAREMMA STEEL SKIRTING	AGSZZMRMASTE005527	60X8
MAREMMA COPPER SKIRTING	AGSZZMRMACOP005523	60X8
MAREMMA GREY SKIRTING	AGSZZMRMAGRY005528	60X8
MAREMMA SAND SKIRTING	AGSZZMRMASND005526	60X8
MAREMMA DARK BROWN SKIRTING	AGSZZMRMADBR005524	60X8
MAREMMA ORANGE SKIRTING	AGSZZMRMAORE005525	60X8
MAREMMA COTTO SKIRTING	AGSZZMRMACOT005529	60X8

PACKAGING | IMBALLI | EMBALLAGES | VERPAKUNGEN | УПАКОВКА

Sizes (cm)	Thickness (mm)	Pz X	M² X	Kg X	RM X	X Sq. Pallet	M² X Sq. Pallet	kg X Sq. Pallet	X Eu. Pallet	M² X Eu. Pallet	kg X Eu. Pallet
60x120	9	2	1.44	30.00	-	-	-	-	30	43.20	921.00
80x80	9	3	1.92	40.00	-	-	-	-	30	57.60	1221.00
60x60	9	4	1.44	30.00	-	-	-	-	30	43.20	921.00
19.7x19.7	9	21	0.18	24.00	-	125	101.25	3,000	-	-	-
9.7x9.7	9	72	0.67	15.00	-	90.00	60.3	1,350	-	-	-
STEP 30X120	9	2	0.72	20	-	-	-	-	-	-	-
SKIRTING 75x8	9	10	-	14.40	7.5	-	-	-	66	-	950.40
SKIRTING 60x8	9	18	-	19.00	-	80	-	1520.00	-	-	-
MOSAIC 30X30	9	10	-	14	-	48.00	-	-	48	-	672
MOSAIC 25.5x29.5	9	10	-	17.5	-	54	-	980.00	-	-	-

WALL: MAREMMA BROWN 19.7X19.7CM
FLOOR: MAREMMA SAND 60X120CM

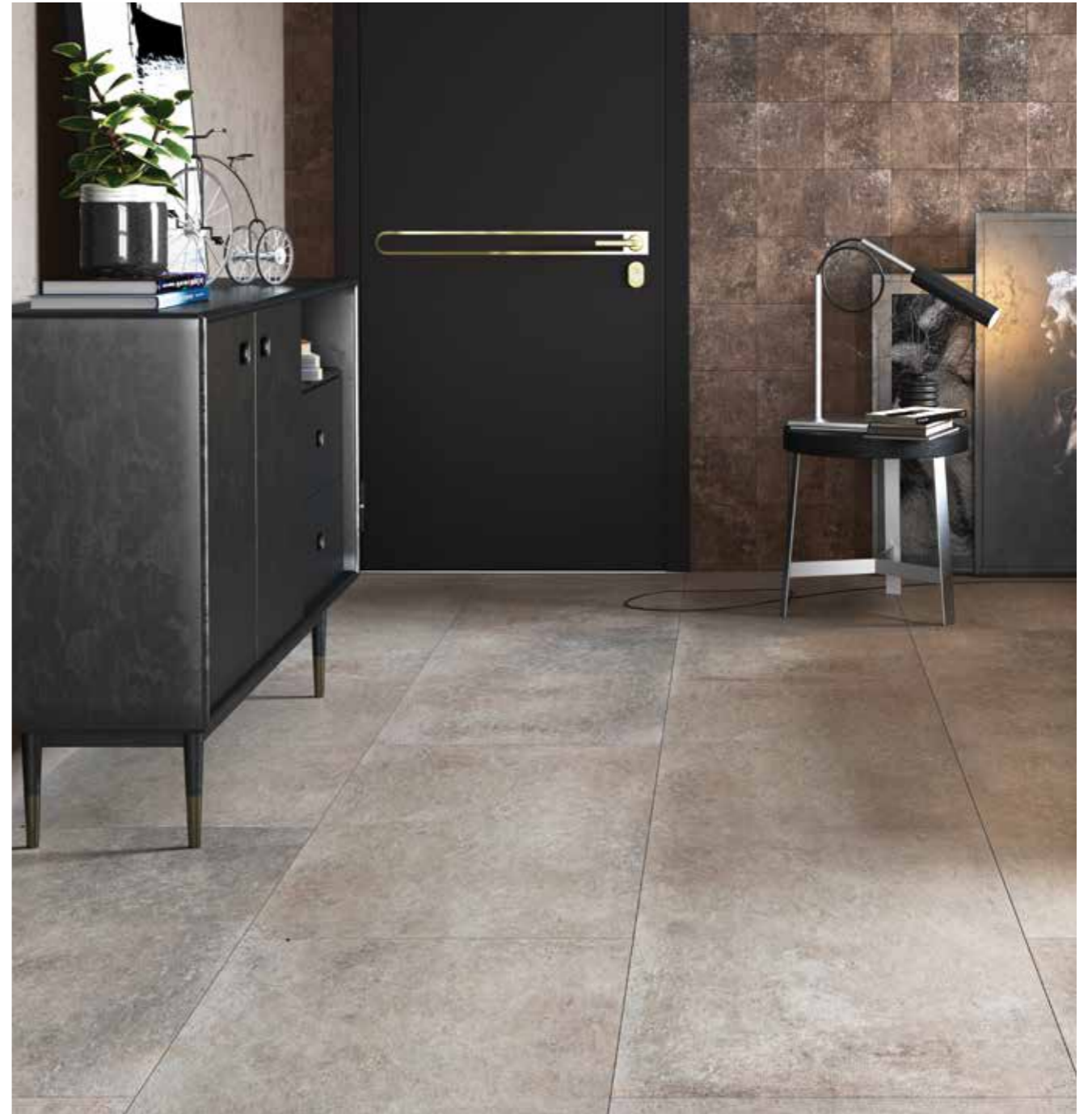



FLOOR: SALENTO BROWN 60X60 CM

SALENTO



SALENTO

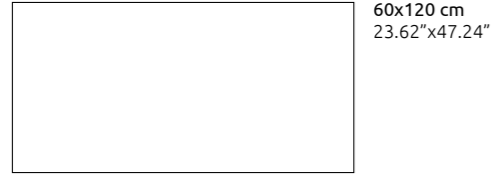

60x120 cm
23.62"x47.24"

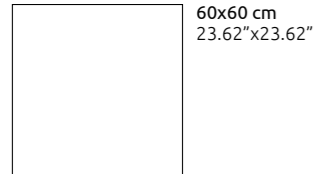

60x60 cm
23.62"x23.62"

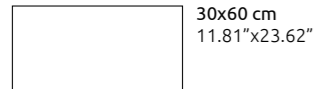

30x60 cm
11.81"x23.62"

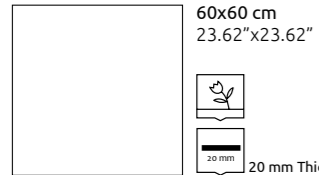

60x60 cm
23.62"x23.62"

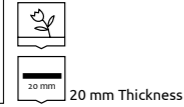

20 mm Thickness

Klima is a new generation ceramic that, thanks to special materials, is able to absorb and repel heat according to individual needs. Suitable for both indoor and outdoor applications, for flooring or external walls, to achieve maximum comfort with minimum energy impact.

SALENTO BEIGE



SALENTO BROWN



SALENTO GREY



Name	Code	Size(CM)	Code	Size(CM)	Code	Size(CM)
SALENTO BEIGE	A12GSLTO-BEE.A6X5R	60x120	A06GSLTO-BEE.A6X0R	60x60	A06GSLTO-BEE.A6X7R	60x60
SALENTO BROWN	A12GSLTO-BRN.A6X5R	60x120	A06GSLTO-BRN.A6X0R	60x60	A06GSLTO-BRN.A6X7R	60x60
SALENTO GREY	A12GSLTO-GRY.A6X5R	60x120	A06GSLTO-GRY.A6X0R	60x60	A06GSLTO-GRY.A6X7R	60x60
SALENTO BEIGE	A09GSLTO-BEE.A6X0R	30x60				
SALENTO BROWN	A09GSLTO-BRN.A6X0R	30x60				
SALENTO GREY	A09GSLTO-GRY.A6X0R	30x60				

PACKAGING | IMBALLI | EMBALLAGES | VERPAKUNGEN | УПАКОВКА

Sizes (cm)	Thickness (mm)	Pz X	M² X	Kg X	X Eu. Pallet	M² X Eu. Pallet	kg X Eu. Pallet
60x120	9	2	1.44	30.00	30	43.20	921.00
60x60	9	4	1.44	30.00	30	43.20	921.00
30x60	9	6	1.08	23.00	48	51.84	1125.00
60x60	20	2	0.72	32.00	30	21.60	1000.00

WALL: SHINE STONE DARK GREY 15X60 CM



SHINE STONE

WALL: SHINE STONE DARK GREY 15X60 CM
FLOOR: SHINE STONE DARK GREY 60X60 CM,
SHINE STONE DARK GREY 30X60 CM (R11)

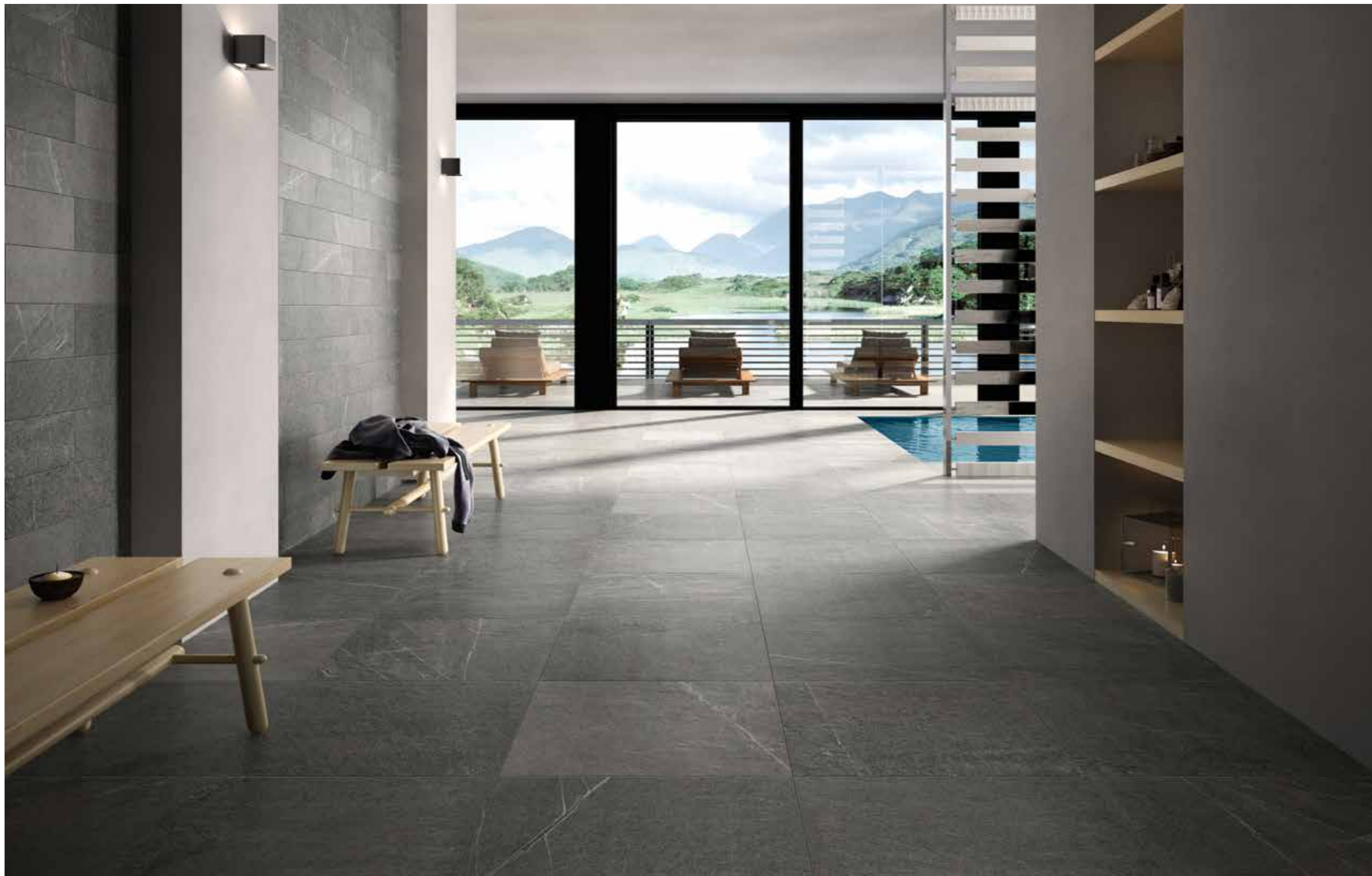



SHINE STONE

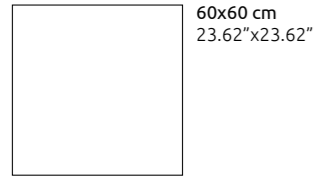

60x60 cm
23.62"x23.62"



30x60 cm
11.81"x23.62"



30x60 cm
11.81"x23.62"



SHINE STONE WHITE



SHINE STONE IVORY



SHINE STONE GREY



SHINE STONE BEIGE



SHINE STONE DARK GREY



SHINE STONE DARK BEIGE



SHINE STONE BLACK



SHINE STONE BROWN



SHINE STONE



SHINE STONE IVORY MOSAIC 2.3X2.3

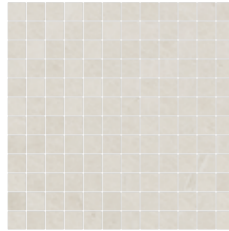

30X30 CM / 11.81"X11.81"

Name	Code	Size(CM)
SHINE STONE WHITE	A06GZSHS-WH0.M2R	60X60
SHINE STONE GREY	A06GZSHS-GY0.M2R	60X60
SHINE STONE DARK GREY	A06GZSHS-DGY.M2R	60X60
SHINE STONE BLACK	A06GZSHS-BK0.M2R	60X60
SHINE STONE IVORY	A06GZSHS-IV0.M2R	60X60
SHINE STONE BEIGE	A06GZSHS-BE0.M2R	60X60
SHINE STONE DARK BEIGE	A06GZSHS-DBE.M2R	60X60
SHINE STONE BROWN	A06GZSHS-BR0.M2R	60X60

Name	Code	Size(CM)	Name	Code	Size(CM)	Code	Size(CM)
SHINE STONE WHITE MOSAIC 2.3X2.3	AM-GZSHS-WH.2R/2H	30X30	SHINE STONE WHITE	A09GZSHS#WH0.M2R	30X60	A09GZSHS#WH0.MYR	30X60 R11
SHINE STONE GREY MOSAIC 2.3X2.3	AM-GZSHS-GY.2R/2H	30X30	SHINE STONE GREY	A09GZSHS#GY0.M2R	30X60	A09GZSHS#GY0.MYR	30X60 R11
SHINE STONE DARK GREY MOSAIC 2.3X2.3	AM-GZSHS-DGY.2R/2H	30X30	SHINE STONE DARK GREY	A09GZSHS#DGY.M2R	30X60	A09GZSHS#DGY.MYR	30X60 R11
SHINE STONE BLACK MOSAIC 2.3X2.3	AM-GZSHS-BK.2R/2H	30X30	SHINE STONE BLACK	A09GZSHS#BK0.M2R	30X60	A09GZSHS#BK0.MYR	30X60 R11
SHINE STONE IVORY MOSAIC 2.3X2.3	AM-GZSHS-IV.2R/2H	30X30	SHINE STONE IVORY	A09GZSHS#IV0.M2R	30X60	A09GZSHS#IV0.MYR	30X60 R11
SHINE STONE BEIGE MOSAIC 2.3X2.3	AM-GZSHS-BE.2R/2H	30X30	SHINE STONE BEIGE	A09GZSHS#BE0.M2R	30X60	A09GZSHS#BE0.MYR	30X60 R11
SHINE STONE DARK BEIGE MOSAIC 2.3X2.3	AM-GZSHS-DBE.2R/2H	30X30	SHINE STONE DARK BEIGE	A09GZSHS#DBE.M2R	30X60	A09GZSHS#DBE.MYR	30X60 R11
SHINE STONE BROWN MOSAIC 2.3X2.3	AM-GZSHS-BR.2R/2H	30X30	SHINE STONE BROWN	A09GZSHS#BR0.M2R	30X60	A09GZSHS#BR0.MYR	30X60 R11

PACKAGING | IMBALLI | EMBALLAGES | VERPAKUNGEN | УПАКОВКА

Sizes (cm)	Thickness (mm)	Pz X	M² X	Kg X	X Eu. Pallet	M² X Eu. Pallet	kg X Eu. Pallet
60X60	9	4	1.44	30.00	30	43.20	921.00
60X60	20.00	2	0.72	32.00	30	21.60	1,000.00
30X60	9	6	1.08	23.00	48	51.84	1125.00
MOSAIC 30X30	9	10	-	14.00	48	-	672.00

WALL: SHINE STONE IVORY MOSAIC 2.3X2.3, 30X30 CM

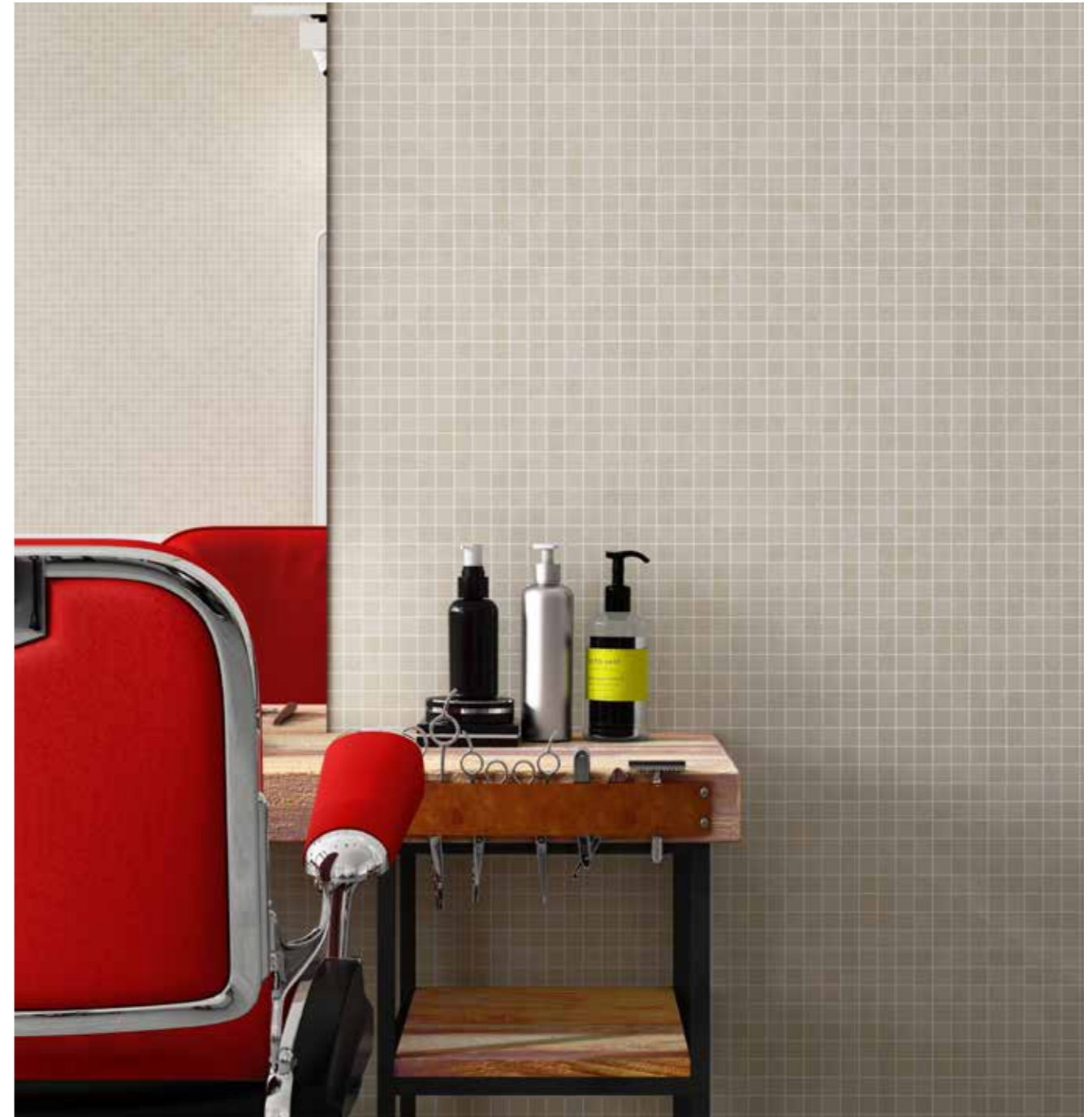

WALL: EVOQUE METAL ICE DECOR 60X60 CM



EVOQUE METAL
EVOQUE METAL XL

WALL: EVOQUE METAL ICE DECOR 60X60 CM
FLOOR: EVOQUE METAL GREY 60X60 CM



WALL: EVOQUE METAL GREY 60X120 CM
FLOOR: DESIGN CONCRETE CLAY 75X75 CM



WALL: EVOQUE METAL XL BROWN
FLOOR: EVOQUE METAL XL GREY
COUNTER WALL: EVOQUE METAL XL BROWN



EVOQUE METAL XL

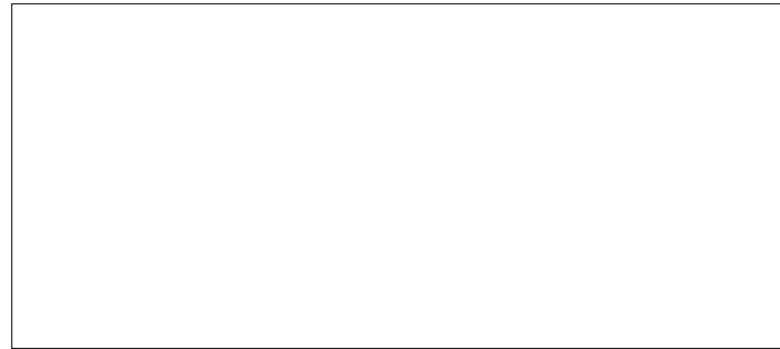

135x305 cm
53.14"x120"



>|< 14.5 mm
0.57"

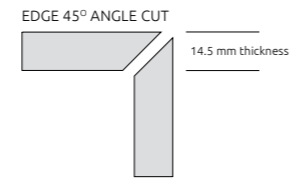

120x260 cm
47.24"x102.36"



>|< 9 mm
0.35"

EVOQUE METAL XL ICE



EVOQUE METAL XL GREY



EVOQUE METAL XL BROWN



Name	Code	Thickness(MM)	Size(CM)	Code	Thickness(MM)	Size(CM)
EVOQUE METAL XL ICE	A83GEVQM-ICE.M0X2R	14.5	135x305	A62GEVQM-ICE.M0X6R	9	120x260
EVOQUE METAL XL GREY	A83GEVQM-GRY.M0X2R	14.5	135x305	A62GEVQM-GRY.M0X6R	9	120x260
EVOQUE METAL XL BROWN	A83GEVQM-BRN.M0X2R	14.5	135x305	A62GEVQM-BRN.M0X6R	9	120x260

Packaging are available upon request | L'imballaggio è disponibile su richiesta | Les emballages sont disponibles sur demande | Verpackungen sind auf Anfrage erhältlich | упаковка предоставляется по запросу

EVOQUE METAL

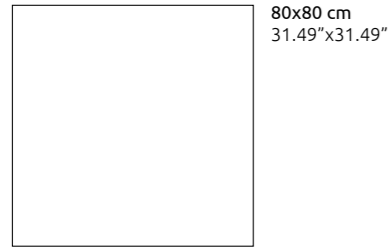
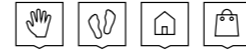

80x80 cm
31.49"x31.49"



60x120 cm
23.62"x47.24"



60x60 cm
23.62"x23.62"

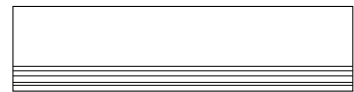

Step
30x120 cm
11.81"x47.24"

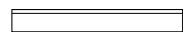

Skirting
60x8 cm
23.62"x3.74"

FINISHES

NATURAL



LAPPATO



EVOQUE METAL ICE



EVOQUE METAL GREY



EVOQUE METAL GREEN GREY



EVOQUE METAL BROWN



EVOQUE METAL ICE DECOR



EVOQUE METAL GREY DECOR



EVOQUE METAL GREEN GREY DECOR



EVOQUE METAL BROWN DECOR



EVOQUE METAL



Name	Code	Size(CM)	Code	Size(CM)
EVOQUE METAL ICE	AGB12EVQMICEZMSSSL	60X120	AGB12EVQMICEZMSS5R	60X120
EVOQUE METAL GREY	AGB12EVQMGRYZMSS5L	60X120	AGB12EVQMGRYZMSS5R	60X120
EVOQUE METAL GREEN GREY	AGB12EVQMGNZMSS5L	60X120	AGB12EVQMGNZMSS5R	60X120
EVOQUE METAL BROWN	AGB12EVQMBRNZMSS5L	60X120	AGB12EVQMBRNZMSS5R	60X120
EVOQUE METAL ICE	AGB06EVQMICEZMSNLL	60X60	AGB06EVQMICEZMSNLR	60X60
EVOQUE METAL GREY	AGB06EVQMGRYZMSNLL	60X60	AGB06EVQMGRYZMSNLR	60X60
EVOQUE METAL GREEN GREY	AGB06EVQMGNZMSNLL	60X60	AGB06EVQMGNZMSNLR	60X60
EVOQUE METAL BROWN	AGB06EVQMBRNZMSNLL	60X60	AGB06EVQMBRNZMSNLR	60X60
EVOQUE METAL ICE	A05GEVQM-ICE.M0X0L	80X80	A05GEVQM-ICE.M0X0R	80X80
EVOQUE METAL GREY	A05GEVQM-GRY.M0X0L	80X80	A05GEVQM-GRY.M0X0R	80X80
EVOQUE METAL GREEN GREY	A05GEVQM-GNG.M0X0L	80X80	A05GEVQM-GNG.M0X0R	80X80
EVOQUE METAL BROWN	A05GEVQM-BRN.M0X0L	80X80	A05GEVQM-BRN.M0X0R	80X80
EVOQUE METAL ICE DECOR	AGD12EVQMICEZMSSSL	60X120		
EVOQUE METAL GREY DECOR	AGD12EVQMGRYZMSSSL	60X120		
EVOQUE METAL GREEN GREY DECOR	AGD12EVQMGNZMSSSL	60X120		
EVOQUE METAL BROWN DECOR	AGD12EVQMBRNZMSSSL	60X120		
EVOQUE METAL ICE DECOR	A05GEVQM-ICE.MDX0L	80X80		
EVOQUE METAL GREY DECOR	A05GEVQM-GRY.MDX0L	80X80		
EVOQUE METAL GREEN GREY DECOR	A05GEVQM-GNG.MDX0L	80X80		
EVOQUE METAL BROWN DECOR	A05GEVQM-BRN.MDX0L	80X80		
EVOQUE METAL ICE DECOR	AGD06EVQMICEZMSSSL	60X60		
EVOQUE METAL GREY DECOR	AGD06EVQMGRYZMSSSL	60X60		
EVOQUE METAL GREEN GREY DECOR	AGD06EVQMGNZMSSSL	60X60		
EVOQUE METAL BROWN DECOR	AGD06EVQMBRNZMSSSL	60X60		
EVOQUE METAL ICE STEP	AGTZZEVQMICE005806	30X120	AGTZZEVQMICE005808	30X120
EVOQUE METAL GREY STEP	AGTZZEVQMGRY005805	30X120	AGTZZEVQMGRY005807	30X120
EVOQUE METAL GREEN GREY STEP	AGTZZEVQMGN006863	30X120	AGTZZEVQMGN006862	30X120
EVOQUE METAL BROWN STEP	AGTZZEVQMBRN005804	30X120	AGTZZEVQMBRN005809	30X120
EVOQUE METAL ICE SKIRTING	AGSZZEVQMICE005763	60X8	AGSZZEVQMICE005750	60X8
EVOQUE METAL GREY SKIRTING	AGSZZEVQMGRY005762	60X8	AGSZZEVQMGRY005749	60X8
EVOQUE METAL GREEN GREY SKIRTING	AGSZZEVQMGN006860	60X8	AGSZZEVQMGN006871	60X8
EVOQUE METAL BROWN SKIRTING	AGSZZEVQMBRN005761	60X8	AGSZZEVQMBRN005748	60X8

PACKAGING | IMBALLI | EMBALLAGES | VERPAKUNGEN | УПАКОВКА

Sizes (cm)	Thickness (mm)	Pz X	M ² X	Kg X	RM X	Sq. Pallet	M ² X Sq. Pallet	kg X Sq. Pallet	Eu. Pallet	M ² X Eu. Pallet	kg X Eu. Pallet
60X120	9	2	1.44	30.00	-	-	-	-	30	43.20	921.00
80x80	9	3	1.92	40.00	-	-	-	-	30	57.60	1221.00
60X60	9	4	1.44	30.00	-	-	-	-	30	43.20	921.00
STEP 30X120	9	2	0.72	20	-	-	-	-	-	-	-
SKIRTING 75x8	9	10	-	14.40	7.5	-	-	-	66	-	950.40
SKIRTING 60x8	9	18	-	19.00	-	80	-	1520.00	-	-	-

WALL: EVOQUE METAL BROWN 60X120 CM,
FLOOR: EVOQUE METAL ICE 60X120 CM



SIGNATURE
COLLECTION

SLABS

WALL: PREZIOSI PEARL 120X260 CM



PREZIOSI



WALL: PREZIOSI DEEP BLUE 120X260 CM



WALL: PREZIOSI RIO 120X260 CM



WALL: PREZIOSI ROCK 120X260 CM

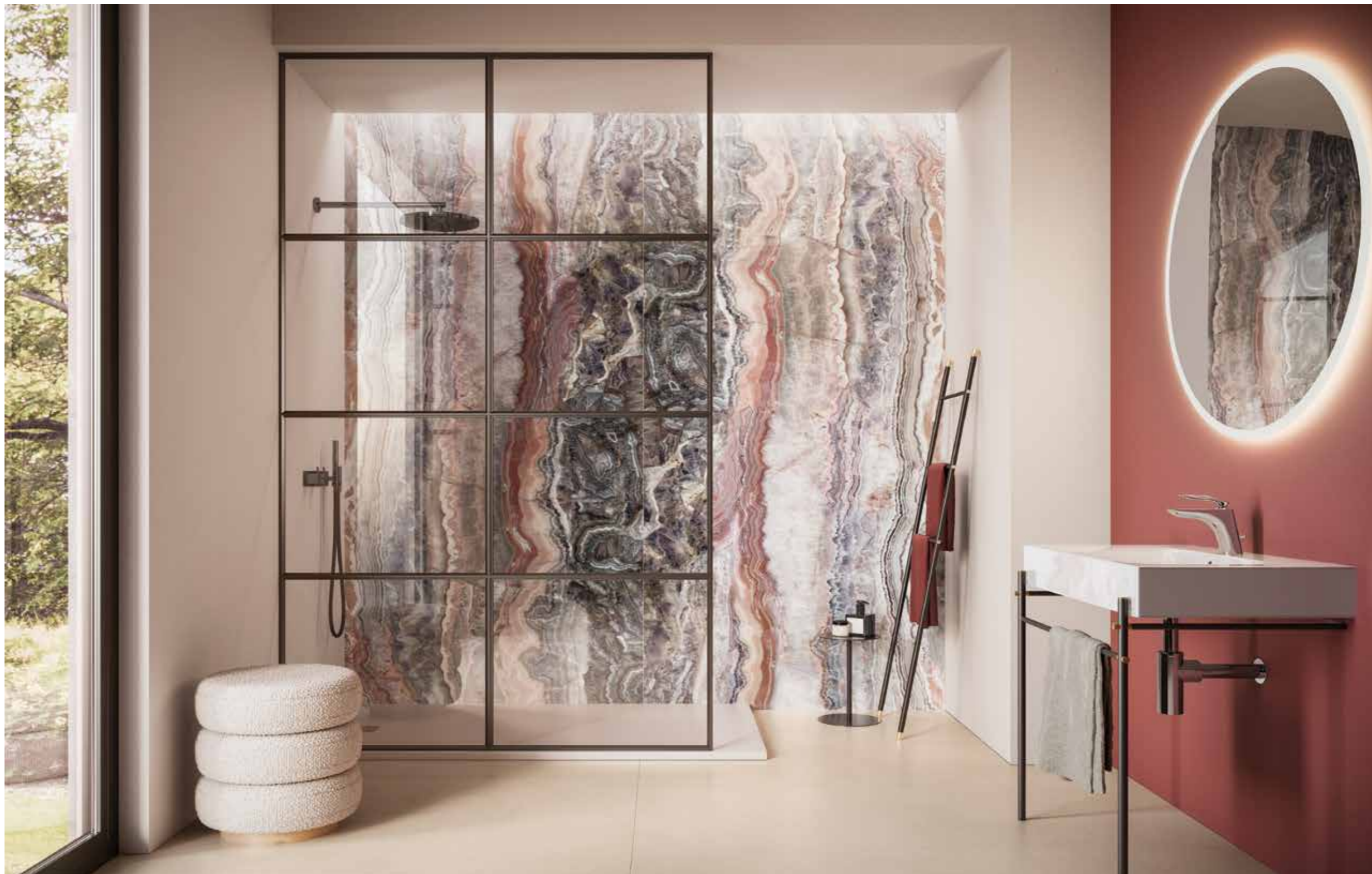

PREZIOSI



120x260 cm
47.24"x94.48"



>|< 6 mm
0.23"

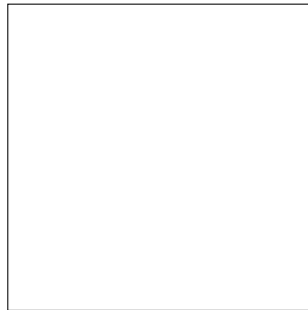

120x120 cm
47.24"x47.24"

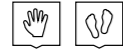

>|< 9 mm
0.35"

Name	Code	Size(CM)	Code	Size(CM)
PREZIOSI GREEN	A62GPRZS-GRE.N0X6P	120x260	A22GPRZS-GRE.N0X5P	120x120
PREZIOSI PLUM	A62GPRZS-PLM.N0X6P	120x260	A22GPRZS-PLM.N0X5P	120x120
PREZIOSI DEEP BLUE	A62GPRZS-DPB.N0X6P	120x260	A22GPRZS-DPB.N0X5P	120x120
PREZIOSI PEARL	A62GPRZS-PRL.N0X6P	120x260	A22GPRZS-PRL.N0X5P	120x120
PREZIOSI RIO	A62GPRZS-RIO.N0X6P	120x260	A22GPRZS-RIO.N0X5P	120x120
PREZIOSI ROCK	A62GPRZS-RCK.N0X6P	120x260	A22GPRZS-RCK.N0X5P	120x120
PREZIOSI OCEAN	A62GPRZS-OCN.N0X6P	120x260	A22GPRZS-OCN.N0X5P	120x120

PACKAGING | IMBALLI | EMBALLAGES | VERPAKUNGEN | УПАКОВКА

Sizes (cm)	Thickness (mm)	Pz / Kg	M² / Pz	Pz X				Dimentions (cm)		
				Pz X	M² X	kg X	Length	Height	Width	
120x260	6	44.00	3.12	20	62.40	1000.00	267	33.50	133	

Sizes (cm)	Thickness (mm)	Pz X	M² X	Kg X	Pz X		kg X	Dimentions (cm)		
					Pz X	M² X		Length	Height	Width
120x120	9	2	2.88	62.00	28	80.64	1766.00	122	76	134
120x120	9	2	2.88	62.00	20	57.60	1260.00	122	122	58

PREZIOSI ROCK



PREZIOSI OCEAN



PREZIOSI GREEN



PREZIOSI



PREZIOSI RIO

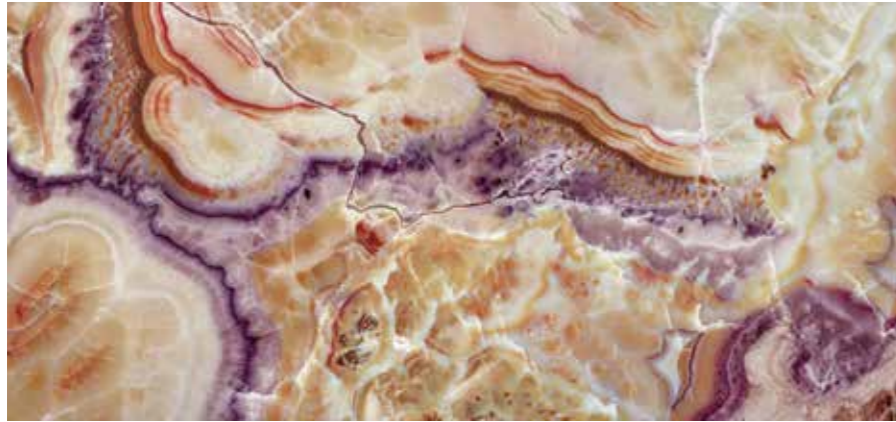

PREZIOSI PLUM

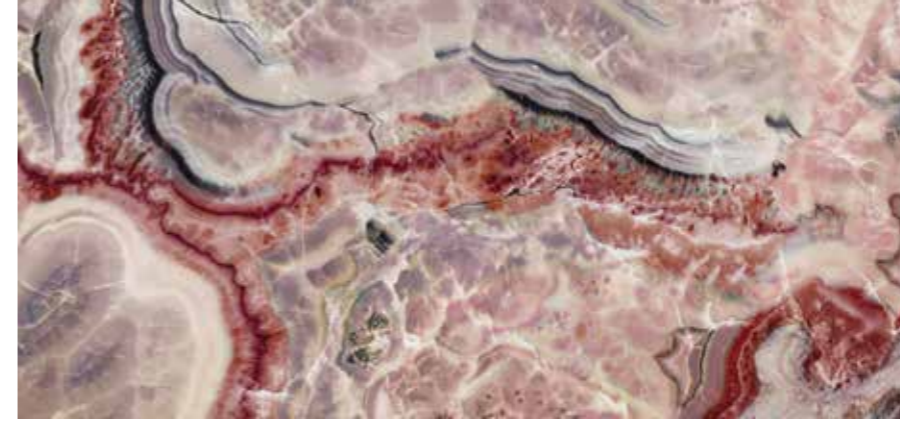

PREZIOSI PEARL

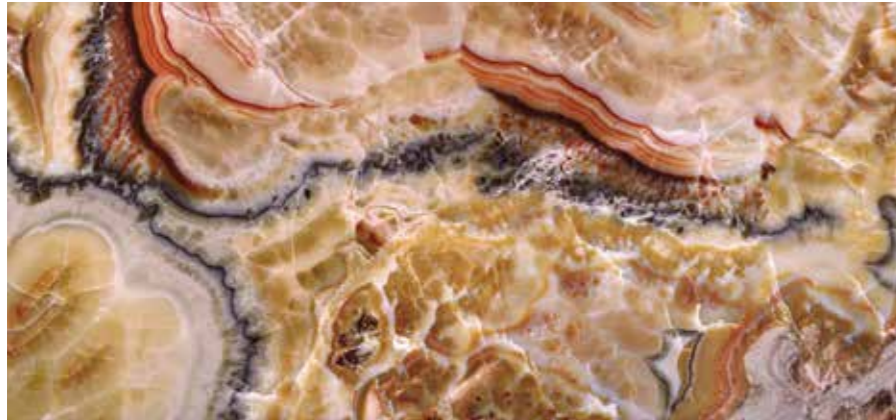

PREZIOSI DEEP BLUE



SIGNATURE
COLLECTION

WOOD

FLOOR: CIRCLE WOOD NUT 19.5X120 CM



CIRCLE WOOD

FLOOR: CIRCLE WOOD GREY 19.5X120 CM



WALL: CIRCLE WOOD BROWN 19.5X120 CM
FLOOR: CIRCLE WOOD BROWN 19.5X120 CM



CIRCLE WOOD



19.5x120 cm
7.67"x47.24"

CIRCLE WOOD IVORY



CIRCLE WOOD GREY



CIRCLE WOOD NUT



CIRCLE WOOD BEIGE



CIRCLE WOOD BROWN



Name	Code	Size(CM)
CIRCLE WOOD IVORY	A99GZCRW#IV0.W25SR	19.5X120
CIRCLE WOOD GREY	A99GZCRW#GY0.W25SR	19.5X120
CIRCLE WOOD NUT	A99GZCRW#NU0.W25SR	19.5X120
CIRCLE WOOD BEIGE	A99GZCRW#BE0.W25SR	19.5X120
CIRCLE WOOD BROWN	A99GZCRW#BR0.W25SR	19.5X120

PACKAGING | IMBALLI | EMBALLAGES | VERPAKUNGEN | УПАКОВКА

Sizes (cm)	Thickness (mm)	Pz X	M ² X	Kg X	X Eu. Pallet	M ² X Eu. Pallet	kg X Eu. Pallet
19.50X120	9	5	1.17	25.00	36	42.12	921.00

FLOOR: HARD WOOD BEIGE 19.5X120 CM



HARD WOOD

FLOOR: HARD WOOD BROWN 19.5X120 CM



INDOOR: HARD WOOD IVORY 19.5X120 CM
OUTDOOR: HARD WOOD MUD 19.5X120 CM



HARD WOOD



19.5x120 cm
7.67"x47.24"

HARD WOOD IVORY



HARD WOOD BEIGE



HARD WOOD RED



HARD WOOD BROWN



HARD WOOD MUD



Name	Code	Size(CM)
HARD WOOD IVORY	A99GZHRD#IV0.W2S5R	19.5X120
HARD WOOD BEIGE	A99GZHRD#BE0.W2S5R	19.5X120
HARD WOOD RED	A99GZHRD#RD0.W2S5R	19.5X120
HARD WOOD BROWN	A99GZHRD#BR0.W2S5R	19.5X120
HARD WOOD MUD	A99GZHRD#MUD.W2S5R	19.5X120

PACKAGING | IMBALLI | EMBALLAGES | VERPAKUNGEN | УПАКОВКА

Sizes (cm)	Thickness (mm)	Pz X	M² X	Kg X	X Eu. Pallet	M² X Eu. Pallet	kg X Eu. Pallet
19.50X120	9	5	1.17	25.00	36	42.12	921.00



SUGI BAN WOOD

FLOOR: SUGI BAN WOOD KURO BLACK 19.5X120
CM



FLOOR: SUGI BAN WOOD KASSHOKU BROWN
19.5X120 CM

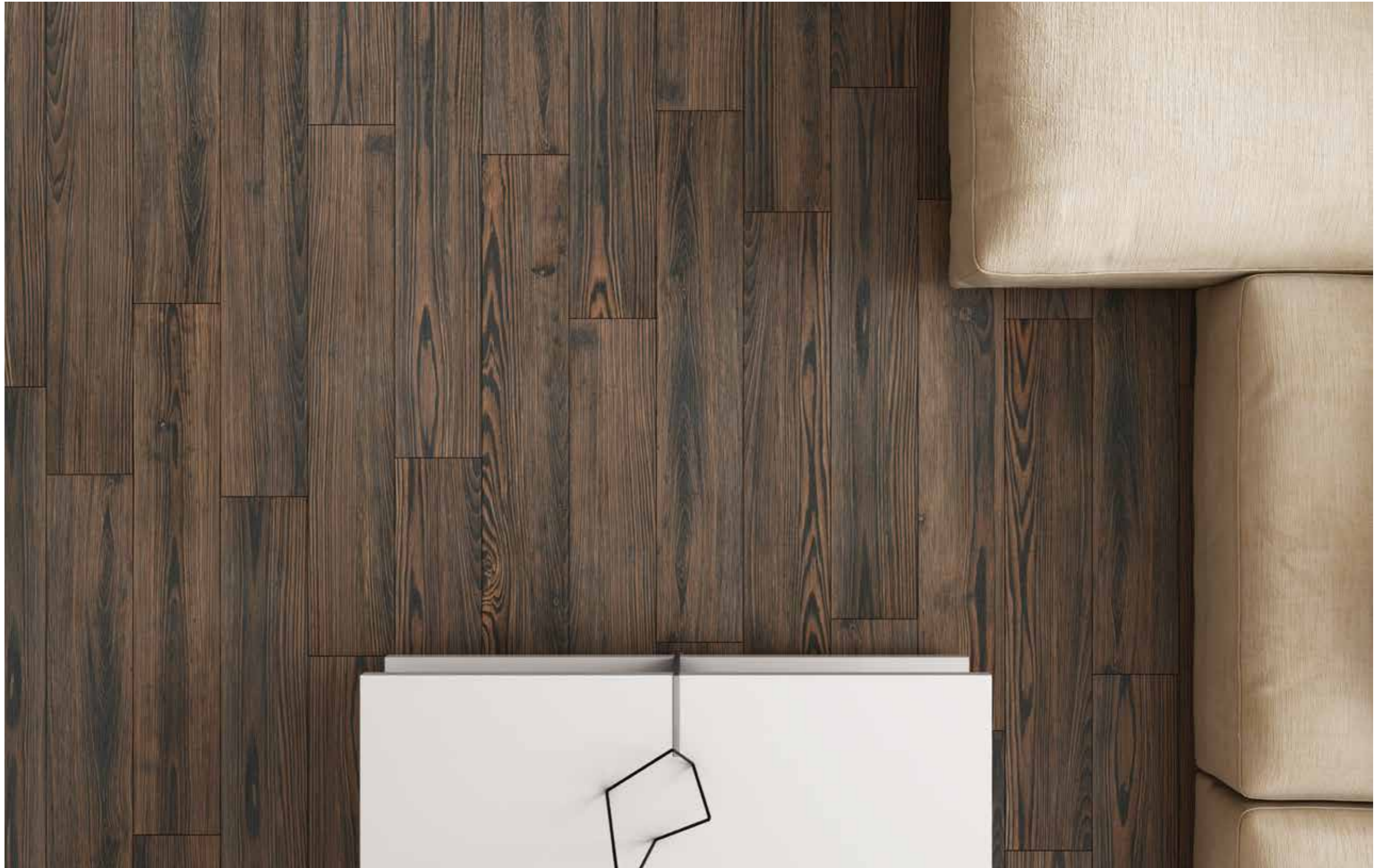

SUGI BAN WOOD



19.5x120 cm
7.67"x47.24"

SUGI BAN WOOD GURE GREY



SUGI BAN WOOD KASSHOKU BROWN



SUGI BAN WOOD BEJU BEIGE



SUGI BAN WOOD SHIRO WHITE



SUGI BAN WOOD BORU BLUE



SUGI BAN WOOD KURO BLACK



Name	Code	Size(CM)
SUGI BAN WOOD GURE GREY	AGX2HSGBNGUGZMH55R	19.5X120
SUGI BAN WOOD KASSHOKU BROWN	AGX2HSGBNKSUZMH55R	19.5X120
SUGI BAN WOOD BEJU BEIGE	AGX2HSGBNBOBZMH55R	19.5X120
SUGI BAN WOOD SHIRO WHITE	AGX2HSGBNSHWZMH55R	19.5X120
SUGI BAN WOOD BORU BLUE	AGX2HSGBNBOBZMH55R	19.5X120
SUGI BAN WOOD KURO BLACK	AGX2HSGBNKBKZMH55R	19.5X120

PACKAGING | IMBALLI | EMBALLAGES | VERPAKUNGEN | УПАКОВКА

Sizes (cm)	Thickness (mm)	Pz X	M² X	Kg X	X Eu. Pallet	M² X Eu. Pallet	kg X Eu. Pallet
19.50X120	9	5	1.17	25.00	36	42.12	921.00

SIGNATURE
COLLECTION

WALL TILES

WALL: MARAKKESH DARK BLUE 7.5X30 CM,
MARAKKESH LIGHT BLUE 7.5X30 CM



MARAKKESH

WALL: MARAKKESH DARK PINK 7.5X30 CM,
MARAKKESH BROWN 7.5X30 CM



WALL: MARAKKESH DARK GREY 6.5X26 CM,
MARAKKESH PINK 6.5X26 CM, MARAKKESH
GREY 6.5X26 CM



MARAKKESH



7.5x30 cm
2.95"x11.81"



6.5x26 cm
2.55"x10.23"



15x15 cm
5.90"x5.90"



Name	Code	Size(CM)	Name	Code	Size(CM)	Name	Code	Size(CM)
MARAKKESH ASH	A05WMRKS-ASH.G6X0U	7.5X30	MARAKKESH GREEN	A05WMRKS-GRE.G6X0U	7.5X30	MARAKKESH BROWN	A05WMRKS-BRN.G6X0U	7.5X30
MARAKKESH GREY	A05WMRKS-GRY.G6X0U	7.5X30	MARAKKESH DARK BLUE	A05WMRKS-DAB.G6X0U	7.5X30	MARAKKESH DARK PINK	A05WMRKS-DEP.G6X0U	7.5X30
MARAKKESH DARK GREY	A05WMRKS-DKG.G6X0U	7.5X30	MARAKKESH LIGHT BLUE	A05WMRKS-LIB.G6X0U	7.5X30	MARAKKESH PINK	A05WMRKS-PIK.G6X0U	7.5X30
MARAKKESH GREIGE	A05WMRKS-GRG.G6X0U	7.5X30	MARAKKESH WHITE	A05WMRKS-WHE.G6X0U	7.5X30	MARAKKESH IVORY	A05WMRKS-IVO.G6X0U	7.5X30
MARAKKESH ASH	A42WMRKS-ASH.G6X0U	6.5X26	MARAKKESH GREEN	A42WMRKS-GRE.G6X0U	6.5X26	MARAKKESH BROWN	A42WMRKS-BRN.G6X0U	6.5X26
MARAKKESH GREY	A42WMRKS-GRY.G6X0U	6.5X26	MARAKKESH DARK BLUE	A42WMRKS-DAB.G6X0U	6.5X26	MARAKKESH DARK PINK	A42WMRKS-DEP.G6X0U	6.5X26
MARAKKESH DARK GREY	A42WMRKS-DKG.G6X0U	6.5X26	MARAKKESH LIGHT BLUE	A42WMRKS-LIB.G6X0U	6.5X26	MARAKKESH PINK	A42WMRKS-PIK.G6X0U	6.5X26
MARAKKESH GREIGE	A42WMRKS-GRG.G6X0U	6.5X26	MARAKKESH WHITE	A42WMRKS-WHE.G6X0U	6.5X26	MARAKKESH IVORY	A42WMRKS-IVO.G6X0U	6.5X26
MARAKKESH ASH	A15SMRKS-ASH.G6X0U	15X15	MARAKKESH GREEN	A15SMRKS-GRE.G6X0U	15X15	MARAKKESH BROWN	A15SMRKS-BRN.G6X0U	15X15
MARAKKESH GREY	A15SMRKS-GRY.G6X0U	15X15	MARAKKESH DARK BLUE	A15SMRKS-DAB.G6X0U	15X15	MARAKKESH DARK PINK	A15SMRKS-DEP.G6X0U	15X15
MARAKKESH DARK GREY	A15SMRKS-DKG.G6X0U	15X15	MARAKKESH LIGHT BLUE	A15SMRKS-LIB.G6X0U	15X15	MARAKKESH PINK	A15SMRKS-PIK.G6X0U	15X15
MARAKKESH GREIGE	A15SMRKS-GRG.G6X0U	15X15	MARAKKESH WHITE	A15SMRKS-WHE.G6X0U	15X15	MARAKKESH IVORY	A15SMRKS-IVO.G6X0U	15X15

PACKAGING | IMBALLI | EMBALLAGES | VERPAKUNGEN | УПАКОВКА

Sizes (cm)	Thickness (mm)	Pz X	M² X	Kg X	Sq. Pallet	M² X Sq. Pallet	kg X Sq. Pallet	Eu. Pallet	M² X Eu. Pallet	kg X Eu. Pallet
15x15	6.5	48	1.08	16.50	108	116.64	1790.00	85	91.80	1425.00
6.5x26	8.5	41	0.70	11.50	120	84.00	1390.00	90	63.00	1055.00
7.5x30	8.5	36	0.81	13.00	90	72.90	1185.00	80	64.80	1060.00

MARAKKESH ASH



MARAKKESH DARK GREY



MARAKKESH GREY



MARAKKESH GREIGE



MARAKKESH IVORY



MARAKKESH BROWN



MARAKKESH PINK



MARAKKESH DARK PINK



MARAKKESH WHITE

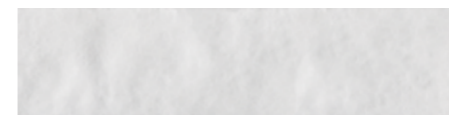

MARAKKESH GREEN



MARAKKESH LIGHT BLUE



MARAKKESH DARK BLUE



WALL: SUBWAY ALL COLOUR 7.5X15 CM



SUBWAY

WALL: SUBWAY NERO BEVEL DECOR 7.5X15 CM



WALL: SUBWAY NERO 15X15 CM (MATT),
SUBWAY IVORY 10X40 CM (MATT)



WALL: SUBWAY GRAPHITE GREY BEVEL DECOR 10X30 CM,
SUBWAY WHITE BEVEL DECOR 10X30 CM



SUBWAY

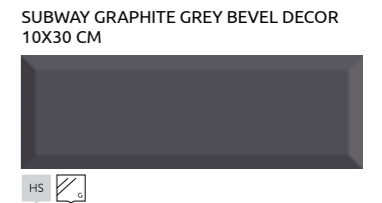
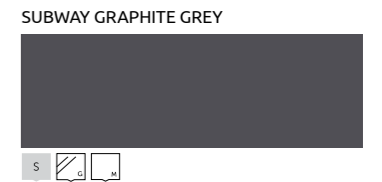
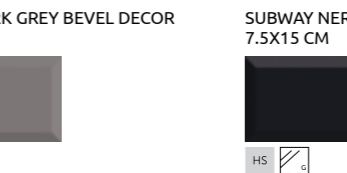
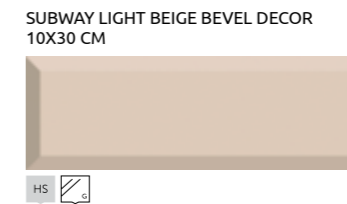
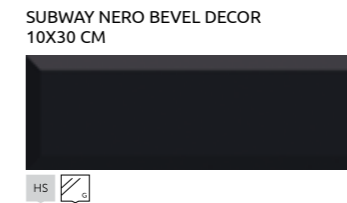
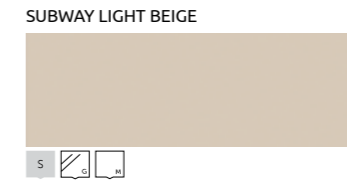
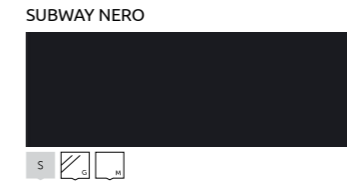
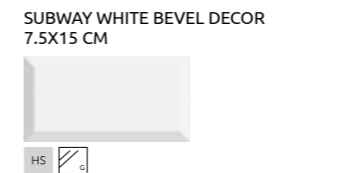
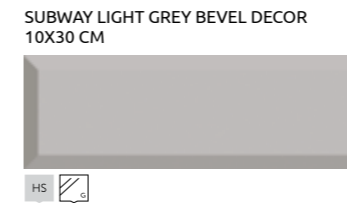
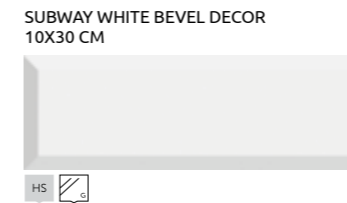
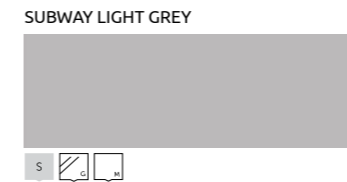
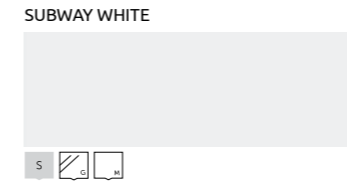
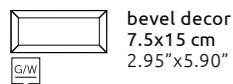
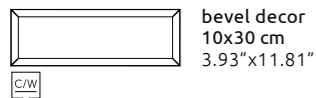
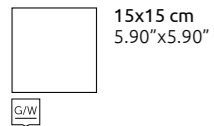
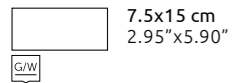
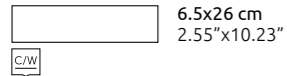
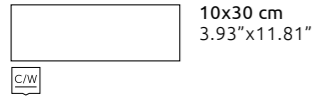

PACKAGING | IMBALLI | EMBALLAGES | VERPAKUNGEN | УПАКОВКА

Sizes (cm)	Thickness (mm)	Pz X	M ² X	Kg X	X Sq. Pallet	M ² X Sq. Pallet	kg X Sq. Pallet	X Eu. Pallet	M ² X Eu. Pallet	kg X Eu. Pallet
15x15	6.5	48	1.08	16.50	108	116.64	1790.00	85	91.80	1425.00
6.5x26	8.5	41	0.70	11.50	120	84.00	1390.00	90	63.00	1055.00
10x30	8.5	27	0.81	13.00	104	84.24	1365.00	88	71.28	1165.00
7.5x15	7.5	88	1.00	17.50	108	108	1900.00	85	85.00	1510.00
7.5x15 (BEVEL DECOR)	10	68	0.77	16.00	108	83.16	1740.00	85	65.45	1380.00
10x30 (BEVEL DECOR)	10	24	0.72	12.50	104	74.88	1315.00	96	69.12	1220.00

SUBWAY

Name	Code 	Size(CM)	Code 	Size(CM)	Code 	Size(CM)	Code 	Size(CM)
SUBWAY WHITE	A42WSUBY-WHE.G0X0U	6.5X26	A42WSUBY-WHE.M0X0U	6.5X26	A15SSUBY-WHE.G0X0U	15X15	A15SSUBY-WHE.M0X0U	15X15
SUBWAY NERO	A42WSUBY-NEO.G0X0U	6.5X26	A42WSUBY-NEO.M0X0U	6.5X26	A15SSUBY-NEO.G0X0U	15X15	A15SSUBY-NEO.M0X0U	15X15
SUBWAY GRAPHITE GREY	A42WSUBY-GPG.G0X0U	6.5X26	A42WSUBY-GPG.M0X0U	6.5X26	A15SSUBY-GPG.G0X0U	15X15	A15SSUBY-GPG.M0X0U	15X15
SUBWAY GREY	A42WSUBY-GRY.G0X0U	6.5X26	A42WSUBY-GRY.M0X0U	6.5X26	A15SSUBY-GRY.G0X0U	15X15	A15SSUBY-GRY.M0X0U	15X15
SUBWAY DARK GREY	A42WSUBY-DKG.G0X0U	6.5X26	A42WSUBY-DKG.M0X0U	6.5X26	A15SSUBY-DKG.G0X0U	15X15	A15SSUBY-DKG.M0X0U	15X15
SUBWAY IVORY	A42WSUBY-IVO.G0X0U	6.5X26	A42WSUBY-IVO.M0X0U	6.5X26	A15SSUBY-IVO.G0X0U	15X15	A15SSUBY-IVO.M0X0U	15X15
SUBWAY LIGHT BEIGE	A42WSUBY-LBE.G0X0U	6.5X26	A42WSUBY-LBE.M0X0U	6.5X26	A15SSUBY-LBE.G0X0U	15X15	A15SSUBY-LBE.M0X0U	15X15
SUBWAY WHITE	A17SSUBY-WHE.G0X0U	7.5X15	A17SSUBY-WHE.M0X0U	7.5X15				
SUBWAY NERO	A17SSUBY-NEO.G0X0U	7.5X15	A17SSUBY-NEO.M0X0U	7.5X15				
SUBWAY GRAPHITE GREY	A17SSUBY-GPG.G0X0U	7.5X15	A17SSUBY-GPG.M0X0U	7.5X15				
SUBWAY GREY	A17SSUBY-GRY.G0X0U	7.5X15	A17SSUBY-GRY.M0X0U	7.5X15				
SUBWAY DARK GREY	A17SSUBY-DKG.G0X0U	7.5X15	A17SSUBY-DKG.M0X0U	7.5X15				
SUBWAY IVORY	A17SSUBY-IVO.G0X0U	7.5X15	A17SSUBY-IVO.M0X0U	7.5X15				
SUBWAY LIGHT BEIGE	A17SSUBY-LBE.G0X0U	7.5X15	A17SSUBY-LBE.M0X0U	7.5X15				
SUBWAY WHITE BEVEL DECOR	A17SSUBY-WHE.GBX4U	7.5X15						
SUBWAY NERO BEVEL DECOR	A17SSUBY-NEO.GBX4U	7.5X15						
SUBWAY DARK GREY BEVEL DECOR	A17SSUBY-DKG.GBX4U	7.5X15						
Name	Code 	Size(CM)	Code 	Size(CM)	Name 	Code	Size(CM)	
SUBWAY WHITE	A13WSUBY-WHE.G0X0U	10X30	A13WSUBY-WHE.M0X0U	10X30	SUBWAY WHITE BEVEL DECOR	A13WSUBY-WHE.GBX4U	10X30	
SUBWAY NERO	A13WSUBY-NEO.G0X0U	10X30	A13WSUBY-NEO.M0X0U	10X30	SUBWAY NERO BEVEL DECOR	A13WSUBY-NEO.GBX4U	10X30	
SUBWAY GRAPHITE GREY	A13WSUBY-GPG.G0X0U	10X30	A13WSUBY-GPG.M0X0U	10X30	SUBWAY GRAPHITE GREY BEVEL DECOR	A13WSUBY-GPG.GBX4U	10X30	
SUBWAY GREY	A13WSUBY-GRY.G0X0U	10X30	A13WSUBY-GRY.M0X0U	10X30	SUBWAY GREY BEVEL DECOR	A13WSUBY-GRY.GBX4U	10X30	
SUBWAY DARK GREY	A13WSUBY-DKG.G0X0U	10X30	A13WSUBY-DKG.M0X0U	10X30	SUBWAY DARK GREY BEVEL DECOR	A13WSUBY-DKG.GBX4U	10X30	
SUBWAY IVORY	A13WSUBY-IVO.G0X0U	10X30	A13WSUBY-IVO.M0X0U	10X30	SUBWAY IVORY BEVEL DECOR	A13WSUBY-IVO.GBX4U	10X30	
SUBWAY LIGHT BEIGE	A13WSUBY-LBE.G0X0U	10X30	A13WSUBY-LBE.M0X0U	10X30	SUBWAY LIGHT BEIGE BEVEL DECOR	A13WSUBY-LBE.GBX4U	10X30	

WALL: SUBWAY GRAPHITE GREY 7.5X15 CM (MATT)

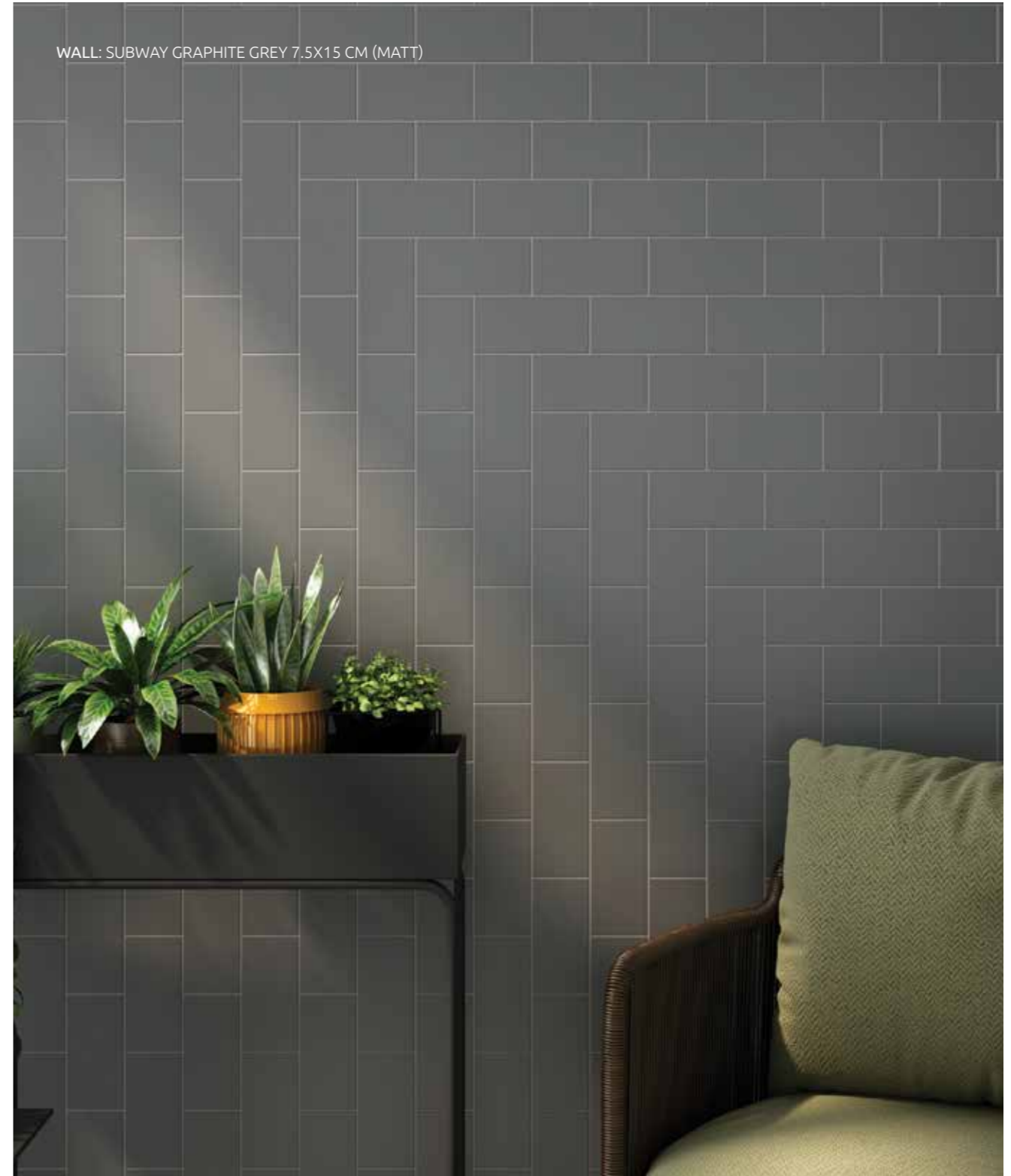

WALL: LOFT BRICK LIGHT GREIGE 6.5X26 CM
LOFT BRICK LIGHT GREIGE DECOR 6.5X26 CM



LOFT BRICK

WALL: LOFT BRICK WHITE 6.5X26 CM
LOFT BRICK BLACK DECOR 6.5X26 CM

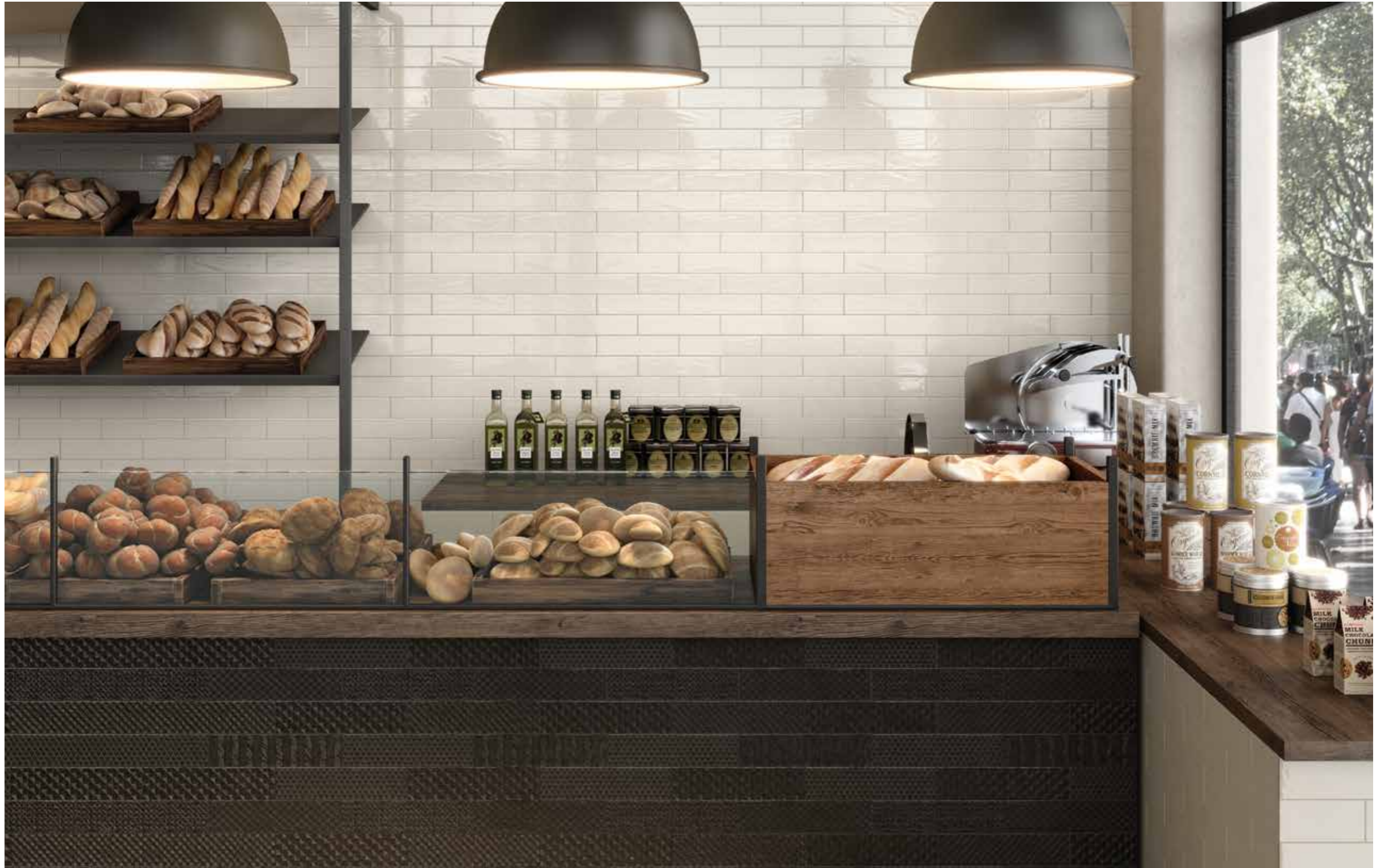

LOFT BRICK



6.5x26 cm
2.55"x10.23"

LOFT BRICK WHITE



LOFT BRICK GREY



LOFT BRICK BLACK



LOFT BRICK WARM WHITE



LOFT BRICK LIGHT GREIGE



LOFT BRICK GREIGE

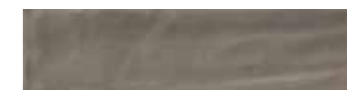

LOFT BRICK WHITE DECOR



6.5x26 cm / 2.55"x10.23"

LOFT BRICK GREY DECOR

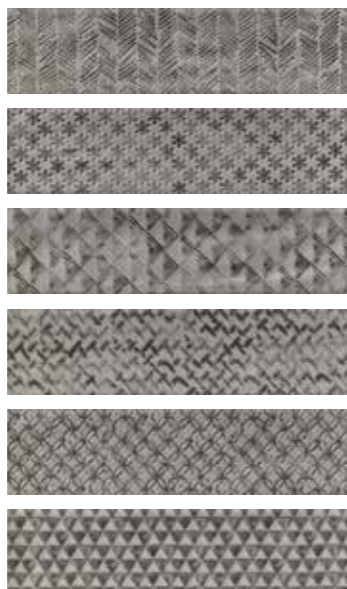

6.5x26 cm / 2.55"x10.23"

LOFT BRICK BLACK DECOR

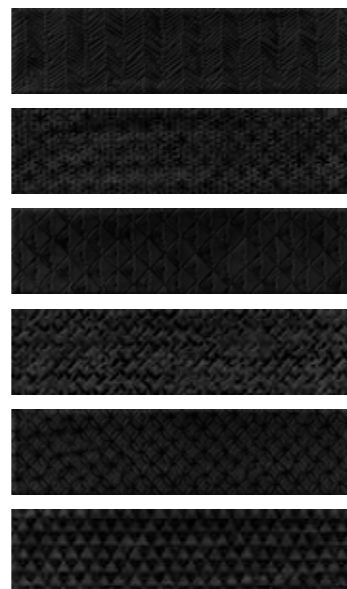

6.5x26 cm / 2.55"x10.23"

LOFT BRICK WARM WHITE DECOR



6.5x26 cm / 2.55"x10.23"

LOFT BRICK LIGHT GREIGE DECOR

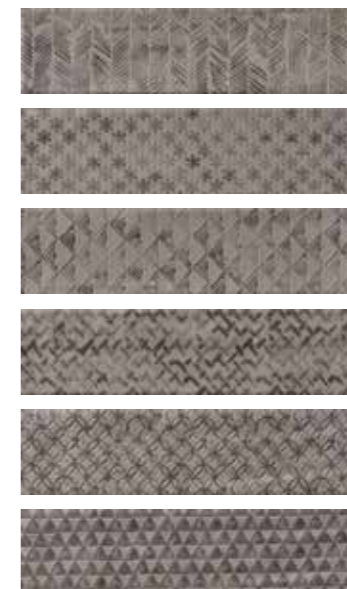

6.5x26 cm / 2.55"x10.23"

LOFT BRICK GREIGE DECOR



6.5x26 cm / 2.55"x10.23"

LOFT BRICK



LOFT BRICK BEIGE



LOFT BRICK BROWN



LOFT BRICK BEIGE DECOR



LOFT BRICK BROWN DECOR

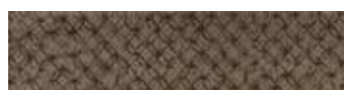

6.5x26 cm / 2.55"x10.23"

6.5x26 cm / 2.55"x10.23"

LOFT BRICK YELLOW



LOFT BRICK LIGHT GREEN



LOFT BRICK YELLOW DECOR



LOFT BRICK LIGHT GREEN DECOR



6.5x26 cm / 2.55"x10.23"

6.5x26 cm / 2.55"x10.23"

PACKAGING | IMBALLI | EMBALLAGES | VERPAKUNGEN | УПАКОВКА

Sizes (cm)	Thickness (mm)	Pz X	M² X	Kg X	RM X	X Sq. Pallet	M² X Sq. Pallet	kg X Sq. Pallet
6.5X26	8.65	41	0.70	11.50	90.00	63	44.10	1,050.00

Name	Code	Size(CM)	Name	Code	Size(CM)
LOFT BRICK WHITE	A56WLOBR-WH0.G0U	6.5X26	LOFT BRICK WARM WHITE DECOR	A56WLOBR-WH0.GDU	6.5X26
LOFT BRICK LIGHT GREIGE	A56WLOBR-LGE.G0U	6.5X26	LOFT BRICK LIGHT GREIGE DECOR	A56WLOBR-LGE.GDU	6.5X26
LOFT BRICK GREY	A56WLOBR-GY0.G0U	6.5X26	LOFT BRICK GREY DECOR	A56WLOBR-GY0.GDU	6.5X26
LOFT BRICK BLACK	A56WLOBR-BK0.G0U	6.5X26	LOFT BRICK BLACK DECOR	A56WLOBR-BK0.GDU	6.5X26
LOFT BRICK WARM WHITE	A56WLOBR-WW0.G0U	6.5X26	LOFT BRICK WARM WHITE DECOR	A56WLOBR-WW0.GDU	6.5X26
LOFT BRICK BEIGE	A56WLOBR-BE0.G0U	6.5X26	LOFT BRICK BEIGE DECOR	A56WLOBR-BE0.GDU	6.5X26
LOFT BRICK BROWN	A56WLOBR-BR0.G0U	6.5X26	LOFT BRICK BROWN DECOR	A56WLOBR-BR0.GDU	6.5X26
LOFT BRICK GREIGE	A56WLOBR-GE0.G0U	6.5X26	LOFT BRICK GREIGE DECOR	A56WLOBR-GE0.GDU	6.5X26
LOFT BRICK LIGHT GREEN	A56WLOBR-LV0.G0U	6.5X26	LOFT BRICK LIGHT GREEN DECOR	A56WLOBR-LV0.GDU	6.5X26
LOFT BRICK YELLOW	A56WLOBR-YE0.G0U	6.5X26	LOFT BRICK YELLOW DECOR	A56WLOBR-YE0.GDU	6.5X26

WALL: AQUARELA BEIGE DECOR 25X90 CM



AQUARELA

WALL: AQUARELA BEIGE 30X90 CM,
AQUARELA BEIGE DECOR 30X90 CM
FLOOR: REVIVE CONCRETE BLADE BEIGE
60X60 CM



AQUARELA



30x90 cm
11.81"x35.43"

AQUARELA WHITE



LS

AQUARELA BEIGE



LS

AQUARELA BEIGE DECOR



30X90 cm / 11.81"x35.43"

HS

AQUARELA GREY



LS

AQUARELA GREY DECOR



30X90 cm / 11.81"x35.43"

HS

AQUARELA BLUE



LS

AQUARELA BLUE DECOR



30X90 cm / 11.81"x35.43"

HS

Name	Code	Size(CM)
AQUARELA WHITE	A39RAQLA-WHE.M6X0R	30X90
AQUARELA BEIGE	A39RAQLA-BEE.M6X0R	30X90
AQUARELA GREY	A39RAQLA-GRY.M6X0R	30X90
AQUARELA BLUE	A39RAQLA-BLE.M6X0R	30X90
AQUARELA BEIGE DECOR	A39RAQLA-BEE.MLX0R	30X90
AQUARELA GREY DECOR	A39RAQLA-GRY.MLX0R	30X90
AQUARELA BLUE DECOR	A39RAQLA-BLE.MLX0R	30X90

PACKAGING | IMBALLI | EMBALLAGES | VERPAKUNGEN | УПАКОВКА

Sizes (cm)	Thickness (mm)	Pz X	M ² X	Kg X	X Sp. Pallet	M ² X Sp. Pallet	kg X Sp. Pallet
30x90	10	7	1.89	33.00	48	90.72	1600.00

WALL: MILKA CONCRETE GREY 30x90 CM,
MILKA CONCRETE GREY DECOR 30x90 CM



MILKA

WALL: MILKA MARBLE WHITE 30X90 CM,
MILKA MARBLE WHITE DECOR 30X90 CM





30x90 cm
11.81"x35.43"

MILKA MARBLE WHITE



MILKA MARBLE WHITE DECOR



30X90 cm / 11.81"x35.43"



HS

MILKA CONCRETE GREY

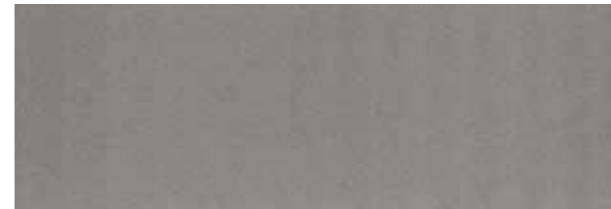

MILKA CONCRETE GREY DECOR



30X90 cm / 11.81"x35.43"



HS

Name	Code	Size(CM)
MILKA MARBLE WHITE	A39RMLKM-WHE.G0X0R	30X90
MILKA MARBLE WHITE DECOR	A39RMLKM-WHE.GWX0R	30X90
MILKA CONCRETE GREY	A39RMLKC-GRY.M0X0R	30X90
MILKA CONCRETE GREY DECOR	A39RMLKC-GRY.MOX0R	30X90

PACKAGING | IMBALLI | EMBALLAGES | VERPAKUNGEN | УПАКОВКА

Sizes (cm)	Thickness (mm)	Pz X	M² X	Kg X	X Sp. Pallet	M² X Sp. Pallet	kg X Sp. Pallet
30x90	10	7	1.89	33.00	48	90.72	1600.00

WALL: MARE SEA GREEN 30X90 CM



MARE

WALL: MARE LIGHT BLUE 30X90 CM,
MARE SEA LIGHT BLUE 30X90 CM



MARE



30x90 cm
11.81"x35.43"

MARE OFF WHITE

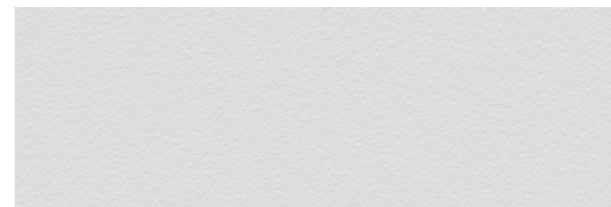

LS

MARE SEA GREEN

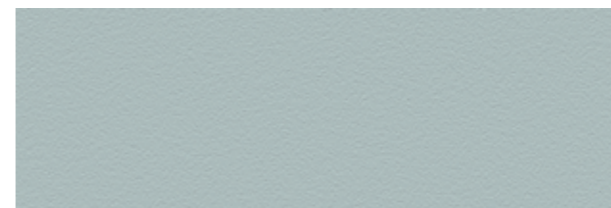

LS

MARE LIGHT BLUE



LS

Name	Code	Size(CM)
MARE OFF WHITE	A39RMARE-OWH.M6X0R	30X90
MARE LIGHT BLUE	A39RMARE-LIB.M6X0R	30X90
MARE BEIGE	A39RMARE-BEE.M6X0R	30X90
MARE ROSE	A39RMARE-RSE.M6X0R	30X90
MARE SEA GREEN	A39RMARE-SEG.M6X0R	30X90

Name	Code	Size(CM)
MARE OFF WHITE DECOR	A39RMARE-OWH.MWX0R	30X90
MARE LIGHT BLUE DECOR	A39RMARE-LIB.MWX0R	30X90
MARE BEIGE DECOR	A39RMARE-BEE.MWX0R	30X90
MARE ROSE DECOR	A39RMARE-RSE.MWX0R	30X90
MARE SEA GREEN DECOR	A39RMARE-SEG.MWX0R	30X90

PACKAGING | IMBALLI | EMBALLAGES | VERPAKUNGEN | УПАКОВКА

Sizes (cm)	Thickness (mm)	Pz X	M² X	Kg X	X Sp. Pallet	M² X Sp. Pallet	kg X Sp. Pallet
30x90	10	7	1.89	33.00	48	90.72	1600.00

MARE BEIGE

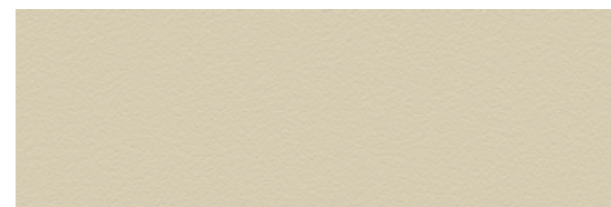

LS

MARE ROSE



LS

MARE



MARE OFF WHITE DECOR



30X90 cm / 11.81"x35.43"

HS

MARE SEA GREEN DECOR



30X90 cm / 11.81"x35.43"

HS

MARE LIGHT BLUE DECOR



30X90 cm / 11.81"x35.43"

HS

MARE BEIGE DECOR



30X90 cm / 11.81"x35.43"

HS

MARE ROSE DECOR



30X90 cm / 11.81"x35.43"

HS

WALL: MARE ROSE 30X90 CM,
MARE ROSE DECOR 30X90 CM



WALL: SPATULA WHITE DECOR 30X90 CM



SPATULA

WALL: SPATULA TERRA COTA 30X90 CM,
SPATULA WHITE DECOR 30X90 CM
FLOOR : SUGI BAN WOOD KASSHOKU
BROWN 19.5X120 CM



WALL: SPATULA DENIM BLUE 40X80 CM,
SPATULA MIX DECOR 40X80 CM



SPATULA



30x90 cm
11.81"x35.43"

SPATULA WHITE



LS

SPATULA BEIGE



LS

SPATULA TURQUOISE



LS

SPATULA TORTORA



LS

SPATULA DENIM BLUE



LS

SPATULA TERRA COTTA



LS

Name	Code	Size(CM)
SPATULA WHITE	A39RSPTL-WHE.M6X0R	30X90
SPATULA BEIGE	A39RSPTL-BEE.M6X0R	30X90
SPATULA TORTORA	A39RSPTL-TOR.M6X0R	30X90
SPATULA TERRACOTTA	A39RSPTL-TCO.M6X0R	30X90
SPATULA DENIM BLUE	A39RSPTL-DMB.M6X0R	30X90
SPATULA TURQUOISE	A39RSPTL-TQS.M6X0R	30X90

Name	Code	Size(CM)
SPATULA OFF WHITE DECOR	A39RSPTL-WHE.MJX0R	30X90
SPATULA BEIGE DECOR	A39RSPTL-BEE.MJX0R	30X90
SPATULA TORTORA DECOR	A39RSPTL-TOR.MJX0R	30X90
SPATULA TERRACOTTA DECOR	A39RSPTL-TCO.MJX0R	30X90
SPATULA DENIM BLUE DECOR	A39RSPTL-DMB.MJX0R	30X90
SPATULA TURQUOISE DECOR	A39RSPTL-TQS.MJX0R	30X90

PACKAGING | IMBALLI | EMBALLAGES | VERPAKUNGEN | УПАКОВКА

Sizes (cm)	Thickness (mm)	Pz X	M² X	Kg X	X Sp. Pallet	M² X Sp. Pallet	kg X Sp. Pallet
30x90	10	7	1.89	33.00	48	90.72	1600.00

SPATULA



SPATULA WHITE DECOR



30X90 cm / 11.81"x35.43"

HS

SPATULA BEIGE DECOR



30X90 cm / 11.81"x35.43"

HS

SPATULA TURQUOISE DECOR



30X90 cm / 11.81"x35.43"

HS

SPATULA TORTORA DECOR



30X90 cm / 11.81"x35.43"

HS

SPATULA DENIM DECOR



30X90 cm / 11.81"x35.43"

HS

SPATULA TERRA COTTA DECOR



30X90 cm / 11.81"x35.43"

HS

WALL: SPATULA BEIGE DECOR 30X90 CM



SPATULA



40x80 cm
15.74"x31.49"

Name	Code	Size(CM)	Name	Code	Size(CM)
SPATULA WHITE	A48RSPTL-WHE.M6X0R	40X80	SPATULA WHITE DECOR	A48RSPTL-WHE.MJX0R	40X80
SPATULA DARK GREY	A48RSPTL-DKG.M6X0R	40X80	SPATULA DARK GREY DECOR	A48RSPTL-DKG.MJX0R	40X80
SPATULA DENIM BLUE	A48RSPTL-DMB.M6X0R	40X80	SPATULA DENIM BLUE DECOR	A48RSPTL-DMB.MJX0R	40X80
SPATULA IVORY	A48RSPTL-IVO.M6X0R	40X80	SPATULA IVORY DECOR	A48RSPTL-IVO.MJX0R	40X80
SPATULA BEIGE	A48RSPTL-BEE.M6X0R	40X80	SPATULA BEIGE DECOR	A48RSPTL-BEE.MJX0R	40X80
SPATULA TORTORA	A48RSPTL-TOR.M6X0R	40X80	SPATULA TORTORA DECOR	A48RSPTL-TOR.MJX0R	40X80
SPATULA BROWN	A48RSPTL-BRN.M6X0R	40X80	SPATULA BROWN DECOR	A48RSPTL-BRN.MJX0R	40X80
SPATULA MIX DECOR	A48RSPTL-MS2.MDX0R	40X80			

PACKAGING | IMBALLI | EMBALLAGES | VERPAKUNGEN | УПАКОВКА

Sizes (cm)	Thickness (mm)	Pz X	M² X	Kg X	X Sq. Pallet	M² X Sq. Pallet	kg X Sq. Pallet
40X80	10.5	4	1.28	25.00	44	56.32	1100.00



SPATULA IVORY

LS



SPATULA WHITE

LS



SPATULA BEIGE

LS



SPATULA DARK GREY

LS



SPATULA TORTORA

LS

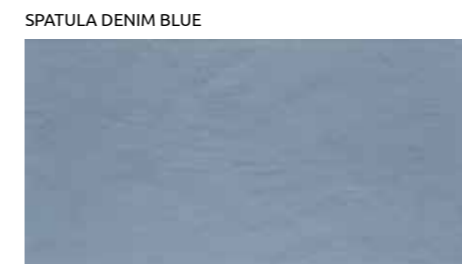

SPATULA DENIM BLUE

LS



SPATULA BROWN

LS

SPATULA



SPATULA IVORY DECOR



40x80 cm / 15.74"x31.49"

HS

SPATULA MIX DECOR

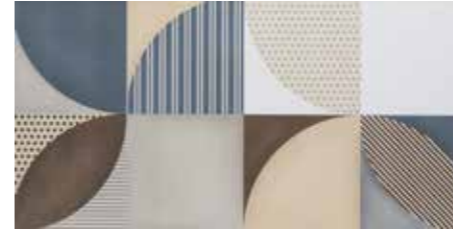

SPATULA WHITE DECOR



40x80 cm / 15.74"x31.49"

HS

SPATULA BEIGE DECOR



40x80 cm / 15.74"x31.49"

HS



40x80 cm / 15.74"x31.49"

S

SPATULA DARK GREY DECOR



40x80 cm / 15.74"x31.49"

HS

SPATULA TORTORA DECOR



40x80 cm / 15.74"x31.49"

HS

SPATULA BROWN DECOR

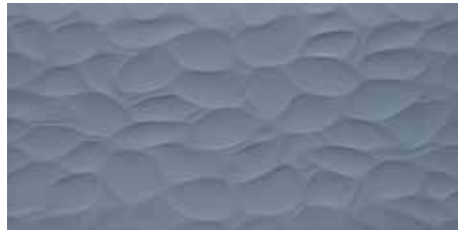

40x80 cm / 15.74"x31.49"

HS

SPATULA BROWN DECOR



40x80 cm / 15.74"x31.49"

HS

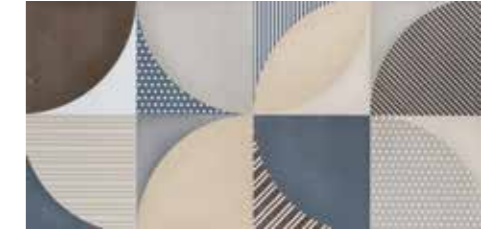

WALL: TENDER WHITE 30X90 CM,
TENDER BEIGE DECOR 3 30X90 CM



TENDER

WALL: TENDER BEIGE 30X90 CM, TENDER AQUA
30X90 CM, TENDER AQUA DECOR 30X90 CM



TENDER



30x90 cm
11.81"x35.43"

TENDER WHITE



LS

TENDER WHITE DECOR



30X90 cm / 11.81"x35.43"

HS

TENDER BEIGE



LS

TENDER BEIGE DECOR



30X90 cm / 11.81"x35.43"

HS

TENDER AQUA



LS

TENDER AQUA DECOR



30X90 cm / 11.81"x35.43"

HS

Name	Code	Size(CM)	Name	Code	Size(CM)
TENDER WHITE	A39RTNDR-OWH.K6X0R	30X90	TENDER WHITE DECOR	A39RTNDR-OWH.KFX0R	30X90
TENDER BEIGE	A39RTNDR-BEE.K6X0R	30X90	TENDER BEIGE DECOR	A39RTNDR-BEE.KFX0R	30X90
TENDER AQUA	A39RTNDR-AQM.K6X0R	30X90	TENDER AQUA DECOR	A39RTNDR-AQM.KFX0R	30X90

PACKAGING | IMBALLI | EMBALLAGES | VERPAKUNGEN | УПАКОВКА

Sizes (cm)	Thickness (mm)	Pz X	M² X	Kg X	X Sp. Pallet	M² X Sp. Pallet	kg X Sp. Pallet
30x90	10	7	1.89	33.00	48	90.72	1600.00

WALL: BRAID GREY LINE DECOR 40X120 CM



BRAID

WALL: BRAID GREY 40X120 CM,
BRAID GREY LINE DECOR 40X120 CM
FLOOR: DESIGN CONCRETE CLAY 60X120 CM



BRAID



40x120 cm
15.74"x47.24"

BRAID ANTIQUE WHITE



S

BRAID GREY



S

BRAID ANTIQUE WHITE DECOR

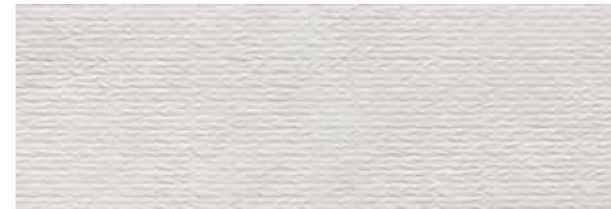

40x120 cm / 15.74"x47.24"

LS

BRAID GREY DECOR



40x120 cm / 15.74"x47.24"

LS

BRAID GREY LINE DECOR



40x120 cm / 15.74"x47.24"

HS

Name	Code	Size(CM)	Name	Code	Size(CM)
BRAID ANTIQUE WHITE	ARB45ZBRAANWZMLNLR	40X120	BRAID GREY LINE DECOR	ARD45ZBRAGRYZMLN1R	40X120
BRAID GREY	ARB45ZBRAGRYZMLNLR	40X120	BRAID SANDY BROWN LINE DECOR	ARD45ZBRASABZMLN1R	40X120
BRAID MOCCASIN	ARB45ZBRAMOIZMLNLR	40X120			
BRAID SANDY BROWN	ARB45ZBRASABZMLNLR	40X120			

PACKAGING | IMBALLI | EMBALLAGES | VERPAKUNGEN | УПАКОВКА

Sizes (cm)	Thickness (mm)	Pz X	M² X	Kg X	X Sq. Pallet	M² X Sq. Pallet	kg X Sq. Pallet
40x120	10.5	3	1.44	29.00	36	50.40	1,064.00

BRAID



BRAID MOCCASIN



S

BRAID SANDY BROWN



S

BRAID MOCCASIN DECOR



40x120 cm / 15.74"x47.24"

LS

BRAID SANDY BROWN DECOR



40x120 cm / 15.74"x47.24"

LS

BRAID SANDY BROWN LINE DECOR



40x120 cm / 15.74"x47.24"

HS

WALL: BRAID GREY 40X120 CM,
BRAID GREY LINE DECOR 40X120 CM
FLOOR: SHINE STONE BEIGE 75X75 CM





WALL:

LEVANTE

WALL: LEVANTE BROWN 40X120 CM,
LEVANTE BROWN DIAMOND DECOR 40X120 CM



LEVANTE



40x120 cm
15.74"x47.24"

LEVANTE LIGHT GREY



LEVANTE LIGHT GREY LINE DECOR



40x120 cm / 15.74"x47.24"

HS

LEVANTE ANTHRACITE



LEVANTE ANTHRACITE DIAMOND DECOR

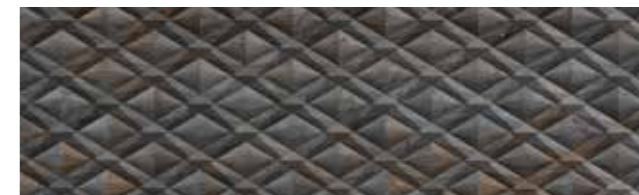

40x120 cm / 15.74"x47.24"

HS

LEVANTE IVORY



LEVANTE IVORY LINE DECOR



40x120 cm / 15.74"x47.24"

HS

LEVANTE BROWN



LEVANTE BROWN DIAMOND DECOR



40x120 cm / 15.74"x47.24"

HS

Name	Code	Size(CM)	Name	Code	Size(CM)
LEVANTE LIGHT GREY	A45RSLBA-LIG.M6X0R	40X120	LEVANTE LIGHT GREY LINE DECOR	A45RSLBA-LIG.MLX0R	40X120
LEVANTE ANTHRACITE	A45RSLBA-ANT.M6X0R	40X120	LEVANTE ANTHRACITE DIAMOND DECOR	A45RSLBA-ANT.MNX0R	40X120
LEVANTE IVORY	A45RSLBA-IVO.M6X0R	40X120	LEVANTE IVORY LINE DECOR	A45RSLBA-IVO.MLX0R	40X120
LEVANTE BROWN	A45RSLBA-BRN.M6X0R	40X120	LEVANTE BROWN DIAMOND DECOR	A45RSLBA-BRN.MNX0R	40X120

PACKAGING | IMBALLI | EMBALLAGES | VERPAKUNGEN | УПАКОВКА

Sizes (cm)	Thickness (mm)	Pz X	M² X	Kg X	X Sq. Pallet	M² X Sq. Pallet	kg X Sq. Pallet
40x120	10.5	3	1.44	29.00	36	50.40	1,064.00

WALL: MATERIA WHITE 40X120CM, MATERIA WHITE
DECOR 60X120 CM



MATERIA

WALL: MATERIA WHITE 40X120CM, MATERIA
WHITE DECOR 60X120 CM
FLOOR: SUGI BAN WOOD KASSHOKU BROWN
19.5X120 CM



MATERIA



40x120 cm
15.74"x47.24"

MATERIA WHITE

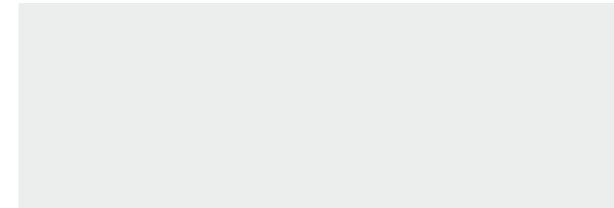

S

MATERIA WHITE BASE



40x120 cm / 15.74"x47.24"

HS

MATERIA WHITE DECOR



40x120 cm / 15.74"x47.24"

HS

Name	Code	Size(CM)
MATERIA WHITE	A45RMATE-WHE.K0X0R	40X120
MATERIA WHITE BASE	A45RMTRB-WHE.KGX0R	40X120
MATERIA WHITE DECOR	A45RMATE-WHE.KGX0R	40X120

PACKAGING | IMBALLI | EMBALLAGES | VERPAKUNGEN | УПАКОВКА

Sizes (cm)	Thickness (mm)	Pz X	M ² X	Kg X	X Sq. Pallet	M ² X Sq. Pallet	kg X Sq. Pallet
40x120	10.5	3	1.44	29.00	36	50.40	1,064.00

WALL: TANDEM WHITE DECOR 40X120 CM



TANDEM

WALL: TANDEM WHITE BASE 40X120 CM,
TANDEM WHITE DECOR 40X120 CM



TANDEM



40x120 cm
15.74"x47.24"

MATERIA WHITE

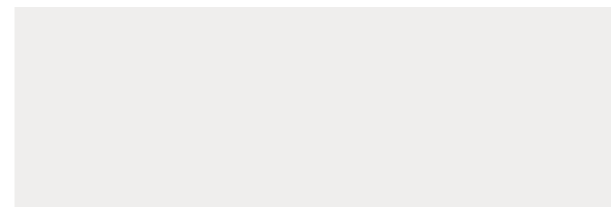

TANDEM WHITE BASE

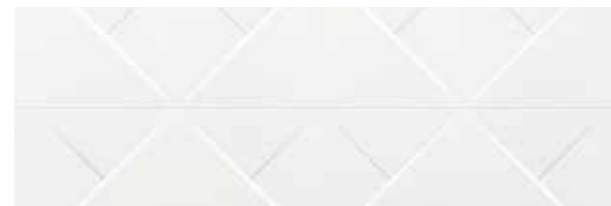

40x120 cm / 15.74"x47.24"

HS

TANDEM WHITE DECOR



40x120 cm / 15.74"x47.24"

HS

NAME	CODE	SIZE(CM)
MATERIA WHITE	A45RMATE-WHE.K0X0R	40X120
TANDEM WHITE BASE	A45RTNDB-WHE.KAX0R	40X120
TANDEM WHITE DECOR	A45RTNDM-WHE.KAX0R	40X120

PACKAGING | IMBALLI | EMBALLAGES | VERPAKUNGEN | УПАКОВКА

Sizes (cm)	Thickness (mm)	Pz X	M² X	Kg X	X Sq. Pallet	M² X Sq. Pallet	kg X Sq. Pallet
40x120	10.5	3	1.44	29.00	36	50.40	1,064.00

WALL: TAUT WHITE DECOR 40X120 CM



TAUT

WALL: TAUT WHITE 40X120 CM, TAUT SALVIA
40X120 CM, TAUT TORTORA MIX DECOR
40X120 CM,
FLOOR: TAUT SALVIA 40X120 CM



TAUT



40x120 cm
15.74"x47.24"

Name	Code	Size(CM)
TAUT WHITE	ARB45TAUTWHEZMLNLR	40X120
TAUT BEIGE	ARB45TAUTBEEZMLNLR	40X120
TAUT TORTORA	ARB45TAUTTORZMLNLR	40X120
TAUT GREY	ARB45TAUTGRYZMLNLR	40X120
TAUT BROWN GREY	ARB45TAUTBGYZMLNLR	40X120
TAUT BLUE	ARB45TAUTBLEZMLNLR	40X120
TAUT SALVIA	ARB45TAUTSLVZMLNLR	40X120
TAUT WHITE DECOR	ARD45TAUTWHEZMHD1R	40X120
TAUT BEIGE DECOR	ARD45TAUTBEEZMHD1R	40X120
TAUT TORTORA DECOR	ARD45TAUTTORZMHD1R	40X120
TAUT GREY DECOR	ARD45TAUTGRYZMHD1R	40X120
TAUT BROWN GREY DECOR	ARD45TAUTBGYZMHD1R	40X120
TAUT BLUE DECOR	ARD45TAUTDLEZMHD1R	40X120
TAUT SALVIA DECOR	ARD45TAUTSLVZMHD1R	40X120
TAUT MIX DECOR	ARD45TAUTMS2ZMHN1R	40X120

PACKAGING | IMBALLI | EMBALLAGES | VERPAKUNGEN | УПАКОВКА

Sizes (cm)	Thickness (mm)	Pz X	M² X	Kg X	X Sq. Pallet	M² X Sq. Pallet	kg X Sq. Pallet
40x120	10.5	3	1.44	29.00	36	50.40	1,064.00

TAUT WHITE



LS

TAUT BEIGE

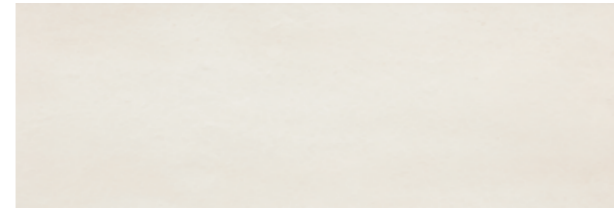

LS

TAUT TORTORA



LS

TAUT GREY



LS

TAUT BROWN GREY



LS

TAUT BLUE



LS

TAUT SALVIA



LS

TAUT



TAUT WHITE DECOR

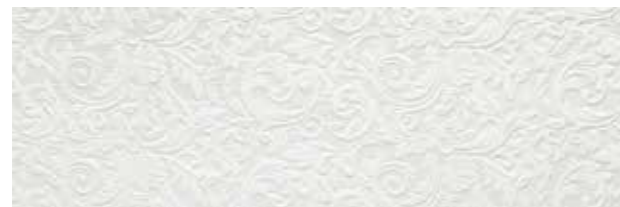

40x120 cm / 15.74"x47.24"

HS

TAUT BEIGE DECOR

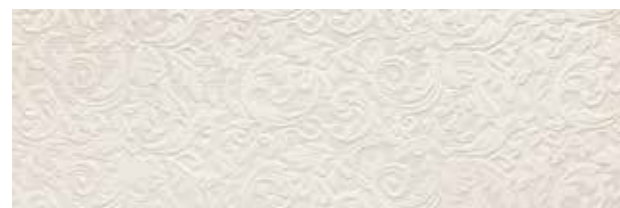

40x120 cm / 15.74"x47.24"

HS

TAUT TORTORA DECOR



40x120 cm / 15.74"x47.24"

HS

TAUT GREY DECOR



40x120 cm / 15.74"x47.24"

HS

TAUT BROWN GREY DECOR



40x120 cm / 15.74"x47.24"

HS

TAUT BLUE DECOR



40x120 cm / 15.74"x47.24"

HS

TAUT SALVIA DECOR



40x120 cm / 15.74"x47.24"

HS

WALL: TAUT TORTORA MIX DECOR 40X120 CM



TAUT TORTORA MIX DECOR



40x120 cm / 15.74"x47.24"

HS

PRODUCT GUIDE

GUIDA AL PRODOTTO
GUIDE AU PRODUIT
INFORMATIONEN ZUM PRODUKT
GUÍA DEL PRODUCTO
РУКОВОДСТВО ПО ПРОДУКТУ

TECHNICAL FEATURES

CARATTERISTICHE TECNICHE | CARACTÉRISTIQUES TECHNIQUES | TECHNISCHE EIGENSCHAFTEN |

CARACTERÍSTICAS TÉCNICAS | ТЕХНИЧЕСКИЕ ОСОБЕННОСТИ

Red body and white body ceramic tiles

RED BODY AND WHITE BODY CERAMIC TILES (BIII):

Red body and white body ceramic tiles (BIII):

Red body and white body Ceramic tiles are made with finest quality clays and with chamotte (a ceramic raw material with high percentage of silica). These raw materials are submitted to dry grinding and suitably mixed and wet and then pressed with hydraulic presses. Quick-cycle support firing is obtained via roller kilns reaching temperatures of approximately 1130 °C. After biscuit glazing, the vitrified product is sintered in a single-layer roller kiln at approximately 1030 °C. The resulting wall tiles have an average bending strength that is higher than 16 N/mm2 in accordance with the UNI EN ISO10545-4 standard and a water absorption level that is higher than 10 %; they belong to the BIII (GL) group according to the International Standard ISO 13006 and UNI EN 14411 standard. This class of products shows virtually no shrinkage during firing; therefore such dimensional consistency results in extremely easy laying.

ADVICE ON LAYING

Ceramic Red/ White body tiles can be laid using either tile adhesives or cement mortar. Under no circumstances should the tiles be wet before laying when using acrylic or vinyl resin based adhesives or two- component organic solvent based adhesives. When laying large sized tiles it is best to adopt the two layer spreading method and, when the laying surface is very large, to provide for suitable expansion joints which must not be spaced more than 4-5 linear meters apart from one another.

IMPORTANT POINTS TO REMEMBER WHILE LAYING THESE TILES

- When laying on wet concrete or plaster, leave to dry for at least one week for each centimetre of thickness.
- When laying on brick, never lay on tile adhesive measuring more than 4-5 mm in thickness. For laying on flexible supports (for example plasterboard panels, polymer panels, etc.) which may result in movement of the tiles, we advise laying on tile adhesive measuring no more than 2-3 mm in thickness and to use class C2 or D1 glues.
- For laying on waterproof brick, which prevents the release of damp, we advise laying on tile adhesive measuring no more than 3 mm in thickness and to use class C2 or D1 glues.
- Avoid laying without expansion joints or joints where stress due to expansion is released directly onto the tile.

CERAMICA A PASTA ROSSA E A PASTA BIANCA (BIII) :

Le piastrelle di ceramica a pasta rossa e a pasta bianca sono prodotte con argille e chamotte (materia prima ceramica con un'alta percentuale di silicio) della migliore qualità. Le materie prime vengono miscelate attraverso un processo chiamato macinazione a secco e quindi pressate con presse idrauliche. Segue un ciclo rapido di cottura in forni rotanti alla temperatura massima di circa 1130°C. Dopo la biscottatura di vetrinatura, il prodotto smaltato viene sintetizzato in un forno rotante a singolo strato a circa 1030°C. Le piastrelle ottenute hanno una resistenza a flessione media superiore a 16/mm2, conformemente allo standard UNI EN ISO10545-4 e un livello di assorbimento idrico superiore al 10%, il che le classifica nel gruppo BIII GL in base allo standard ISO 13006 UNI EN 14411. Questa classe di prodotti non mostra praticamente alcun ritiro durante la cottura; una consistenza di questo tipo consente pertanto una posa estremamente facile.

CONSIGLI PER LA POSA

Le piastrelle di ceramica a pasta rossa o bianca possono essere posate sia utilizzando adesivi per piastrelle che malta cementizia. In nessun caso le piastrelle devono essere bagnate prima della posa quando si usano adesivi a base di resine acriliche o viniliche o adesivi a base di solventi organici a due componenti. Quando si posano piastrelle di dimensioni maggiori, è meglio utilizzare il sistema di spargimento a due strati e, quando la superficie di posa è molto ampia, fornire idonei giunti di espansione a non più di 4-5 metri lineari l'uno dall'altro.

PUNTI IMPORTANTI DA RICORDARE DURANTE LA POSA DI QUESTE PIASTRELLE

- Quando si posa su cemento o intonaco bagnato, lasciare asciugare per almeno una settimana per ciascun centimetro di spessore.
- Quando si posa su mattoni, non usare mai adesivo per piastrelle di spessore superiore a 4-5 mm. Per la posa su supporti flessibili (per esempio pannelli di cartongesso, pannelli polimerici, ecc.) che possono provocare movimenti nelle piastrelle, consigliamo di posare con adesivo per piastrelle di spessore non superiore a 2-3 mm e di utilizzare colle di classe C2 o D1.
- Per la posa su mattoni impermeabili, che impediscono l'eliminazione dell'umidità, consigliamo di posare con adesivo per piastrelle di spessore non superiore a 3 mm e di utilizzare colle di classe C2 o D1.
- Evitare di posare senza giunti di espansione o con giunti in cui la tensione di espansione è scaricata direttamente sulla piastrella.

CARREAUX CÉRAMIQUES À PÂTE ROUGE ET PÂTE BLANCHE (BIII) :

Les carreaux céramique à pâte rouge ou blanche sont faits à base d'argile et de chamotte de très haute qualité (une matière première céramique à forte teneur en silice). Les matières premières sont mélangées grâce à un procédé appelé broyage à sec, puis pressées à l'aide de presses hydrauliques. La cuisson a cycle rapide se fait ensuite à l'aide de fours à rouleaux dont les températures sont d'environ 1130°C. Après l'émaillage de biscuits, le produit vitrifié est frité dans un four à rouleaux monocouche à environ 1030°C. Les carreaux muraux obtenus ont une résistance à la flexion moyenne supérieure à 16/mm2 conformément à la norme UNI EN ISO10545-4 et un taux d'absorption d'eau supérieur à 10 %; classés dans le groupe BIII GL conformément à la norme ISO 13006 UNI EN 14411 . Ce groupe de produits ne présente pratiquement aucune retraite pendant la cuisson et par conséquent, une telle stabilité dimensionnelle facilite considérablement la pose.

RECOMMANDATIONS EN MATIÈRE DE POSE

Les carreaux céramiques en pâte rouge ou blanche peuvent être posés soit à l'aide de colles pour carrelage, soit à l'aide de mortier de ciment. Les carreaux ne doivent en aucun cas être humides avant la pose en cas d'utilisation de colles à base de résine acrylique ou vinylique ou en cas d'utilisation de colles à base de solvant organique bi-composants. Lors de la pose de carreaux de grande taille et lorsque la surface de pose est assez importante, il est préférable d'adopter le procédé d'épandage bi-couches, pour garantir des joints de dilatation appropriés qui ne doivent pas être espacés de plus de 4 à 5 mètres linéaires l'un de l'autre.

POINTS IMPORTANTS À PRENDRE EN CONSIDÉRATION LORS DE LA POSE DE CES CARREAUX

- Lors de la pose sur du béton ou du plâtre frais, laissez sécher pendant au moins une semaine pour chaque centimètre d'épaisseur.
- Lors de la pose sur des briques, évitez de poser sur de la colle pour carrelage de plus de 4 à 5 mm d'épaisseur. Pour la pose sur des supports flexibles (par exemple plaques de plâtre, panneaux de polymère, etc.) pouvant impliquer la mobilité des carreaux, nous vous recommandons de poser sur la colle pour carrelage d'une épaisseur ne dépassant pas 2 à 3 mm et d'utiliser du mortier-colle de classe C2 ou D1.
- Pour la pose sur des briques imperméables ne refoulant pas d'humidité, nous vous recommandons de poser sur la colle pour carrelage d'une épaisseur ne dépassant pas 3 mm et d'utiliser du mortier-colle de classe C2 ou D1.
- Évitez de poser sans joints de dilatation ou des joints où la contrainte, en raison de la dilatation, est directement exercée sur le carreau.

Rotscherbige und weissscherbige Keramikfliesen

ROTSCHERBIGE UND WEISSSCHERBIGE KERAMIKFLIESEN (BIII) :

Rotscherbige oder weißscherbige Keramikfliesen können entweder mit Fliesenkleber oder Zementmörtel verlegt werden. Unter keinen Umständen sollten die Fliesen vor dem Verlegen nass sein, wenn auf Acryl- oder Vinylharz-basierte Kleber oder Zweikomponentenkleber auf Basis von organischen Lösungsmitteln verwendet werden. Beim Verlegen von großformatigen Fliesen ist es am besten, eine Verteilungsmethode aus zwei Schichten zu übernehmen und, sollte die Verlegefläche sehr groß sein, geeignete Dehnungsfugen einzuhalten, die nicht mehr als 4-5 Laufmeter von einander entfernt sind.

TIPPS ZUR VERLEGUNG

Rotscherbige oder weißscherbige Keramikfliesen können entweder mit Fliesenkleber oder Zementmörtel verlegt werden. Unter keinen Umständen sollten die Fliesen vor dem Verlegen nass sein, wenn auf Acryl- oder Vinylharz-basierte Kleber oder Zweikomponentenkleber auf Basis von organischen Lösungsmitteln verwendet werden. Beim Verlegen von großformatigen Fliesen ist es am besten, eine Verteilungsmethode aus zwei Schichten zu übernehmen und, sollte die Verlegefläche sehr groß sein, geeignete Dehnungsfugen einzuhalten, die nicht mehr als 4-5 Laufmeter von einander entfernt sind.

BEIM VERLEGEN DER FLIESEN UNBEDINGT BEACHTEN

- Beim Verlegen auf nassem Beton oder Putz pro Zentimeter Dicke mindestens eine Woche trocknen lassen.
- Beim Verlegen auf Ziegel sollte der Fliesenkleber mit höchstens 4-5 mm Dicke aufgetragen werden. Beim Verlegen auf flexiblen Trägern (beispielsweise Gipskartonplatten, Polymerplatten, usw.) bei denen es zu Bewegungen der Fliesen kommen kann, empfehlen wir die Verlegung auf Fliesenkleber mit einer Dicke von höchstens 2-3 mm und die Verwendung von Klebern der Klasse C2 oder D1.
- Beim Verlegen auf wasserdichten Ziegeln, die eine Freisetzung der Feuchtigkeit verhindern, empfehlen wir die Verlegung auf Fliesenkleber mit einer Dicke von höchstens 3 mm und die Verwendung von Klebern der Klasse C2 oder D1.
- Vermeiden Sie ein Verlegen ohne Dehnungsfugen oder Fugen, bei denen sich Druck direkt durch eine Ausdehnung direkt auf die Fliesen auswirken kann.

CERÁMICA PASTA ROJA O BLANCA (BIII) :

Los azulejos cerámicos en rojo y blanco son elaborados con arcilla y chamota (una materia prima de cerámica con un alto porcentaje de sílice) de la mejor calidad. Las materias primas se mezclan utilizando un proceso llamado amolado seco y después son prensadas utilizando presas hidráulicas. Un horneado de apoyo en ciclo rápido sigue en el proceso utilizando hornos rotativos que alcanzan temperaturas de aproximadamente 1130 °C. Después del vidriado, el producto vitrificado se sinteriza en un horno rotativo de una sola capa a aproximadamente 1030 °C. Los azulejos de pared resultantes tienen una resistencia de flexión promedio de más de 16/mm2 de acuerdo a la norma UNI EN ISO10545-4 y un nivel de absorción de agua de más del 10 %; clasificado como perteneciente al grupo BIII GL de acuerdo a la norma ISO 13006 UNI EN 14411. Esta clase de productos virtualmente muestra una nada de merma al momento de su cocción, y es a esto que se deben tales resultados de consistencia dimensional en una colocación extremadamente fácil.

SUGERENCIAS PARA SU COLOCACION

Los azulejos cerámicos en rojo o blanco pueden ser colocados utilizando ya sean adhesivos de azulejos o morteros de cemento. Los azulejos no deben estar húmedos bajo ninguna circunstancia antes de su colocación al utilizar adhesivos hechos con resina de vinil o resina acrílica, o adhesivos con base de solventes orgánicos con dos componentes. Al colocar azulejos de gran tamaño, es mejor adoptar el método de distribución de dos capas, y cuando la superficie de colocación es muy extensa, proporcionar juntas de dilatación apropiadas, las cuales no deben tener un espacio de más de 4 a 5 metros lineales entre cada una.

PUNTOS IMPORTANTES A RECORDAR AL COLOCAR ESTOS AZULEJOS

- Cuando se coloquen sobre concreto o yeso húmedo, deje secar por lo menos durante una semana por cada centímetro de grosor.
- Cuando coloque un ladrillo, nunca lo coloque sobre adhesivo de azulejos que mida más de a 5 mm de grosor. Para colocar sobre soportes flexibles (como por ejemplo paneles de yeso, paneles de polímero, etc.), lo que puede resultar en movimiento de los azulejos; sugerimos colocar sobre un adhesivo de azulejos que no mida más de 2 a 3 mm en grosor y utilizar pegamentos dase C2 o D1.
- Para colocar sobre ladrillos a prueba de agua, los cuales previenen la liberación de humedad, sugerimos colocar los azulejos sobre adhesivo de azulejos que no midan más de 3 mm de grosor, y utilizar pegamentos clase C2 o D1.
- Evite la colocación de los azulejos sin juntas de dilatación o donde la presión debido a la expansión se libera de forma directa en el azulejo.

Керамическая плитка красное и белое тело

Керамическая плитка из красной и белой глины изготавливается из высококачественных сортов глины и шамота (керамического сырья с высоким содержанием кварца). Эти материалы подвергаются сухому измельчению, смешиваются и увлажняются, после чего формиуются гидравлическим прессом. Быстрый обжиг осуществляется в печах с роликовым подом, достигающих температуры около 1100°C. После бисквитного обжига остеклованный продукт спекается в однослойной печи с роликовым подом при температуре около 1130°C. Полученная настенная плитка имеет среднюю прочность на изгиб более 16 mтге в соответствии со стандартом DIN EN ISO10545-4 и уровень водопоглощения выше 10%; она относится к группе BIII (GL) согласно стандарту ISO 13006 UNI EN 14411. Данный класс продукции практически не демонстрирует усадки при обжиге; следовательно, такая стабильность размеров выражается в крайне легкой укладке.

СОВЕТ ПО УКЛАДКЕ

Керамическая плитка из красной или белой глины может укладываться либо на плиточный клей, либо на цементный раствор. Ни в коем случае не допускайте намокания плитки перед укладкой при использовании клея на основе акриловой или виниловой смолы, или на основе двухкомпонентного органического растворителя. При укладке плитки крупного размера лучше всего применять двухслойный метод нанесения и, при очень большой поверхности укладки, использовать компенсационные швы, расположенные не более чем в 4-5 погонных метрах друг от друга.

ВАЖНЫЕ МОМЕНТЫ ПРИ УКЛАДКЕ ТАКОЙ ПЛИТКИ

- При укладке на влажный бетон или штукатурку дайте подсохнуть не менее одной недели на каждый сантиметр толщины.
- При укладке на кирпич никогда не наносите слой плиточного клея толще 4-5 мм. При укладке на гибкую опору (например, гипсокартонные или полимерные панели и т.д.), что может привести к перемещению плитки, мы рекомендуем наносить слой плиточного клея не более 2-3 мм толщиной и использовать клей класса C2 или D1.
- При укладке на огнеупорный кирпич, предотвращающий выход влаги, мы рекомендуем наносить слой плиточного клея не более 3 мм толщиной и использовать клей класса C2 или D1.
- Избегайте укладки без компенсационных швов в местах, где нагрузка при расширении приходится прямо на плитку.

TECHNICAL CHARACTERISTICS - RED BODY AND WHITE BODY CERAMIC TILES (BIII)







CARATTERISTICHE TECNICHE - CERAMICA A PASTA ROSSA E A PASTA BIANCA (BIII)

CARACTÉRISTIQUES TECHNIQUES - CARREAUX CÉRAMIQUES À PÂTE ROUGE ET PÂTE BLANCHE (BIII)

TECHNISCHE EIGENSCHAFTEN - ROTSCHERBIGE UND WEISSSCHERBIGE KERAMIKFLIESEN (BIII)

CARACTERÍSTICAS TÉCNICAS - CERÁMICA PASTA ROJA O BLANCA (BIII)

ТЕХНИЧЕСКИЕ ХАРАКТЕРИСТИКИ - КЕРАМИЧЕСКАЯ ПЛИТКА КРАСНОЕ И БЕЛОЕ ТЕЛО (BIII)

	TEST DESCRIPTION DESCRIZIONE DEL TESTO DESCRIPTION D'ESSAI TESTBESCHREIBUNG DESCRIPCIÓN DE LA PRUEBA ОПИСАНИЕ ИСПЫТАНИЯ	STANDARD TEST METHOD METODO DI PROVA MÉTHODE D'ESSAI STANDARD STANDARD-TESTMETHODE MÉTODO DE PRUEBA ESTÁNDAR СТАНДАРТНЫЙ ИСПЫТАТЕЛЬНЫЙ МЕТОД	INTERNATIONAL STANDARD ISO 13006 REQUISITI PREVISTI DALLA NORMA ISO 13006 NORME INTERNATIONALE ISO 13006 INTERNATIONALER STANDARD ISO 13006 NORMA INTERNACIONAL ISO 13006 МЕЖДУНАРОДНЫЙ СТАНДАРТ ISO 13006	RAK CERAMICS SPECIFICATIONS RAK CERAMICS - SPECIFICHE SPÉCIFICATIONS RAK CERAMICS RAK CERAMICS SPEZIFIKATIONEN RAK CERAMICS ESPECIFICACIONES СПЕЦИФИКАЦИИ RAK CERAMICS
	LENGTH & WIDTH LUNGHEZZA LARGHEZZA LONGUEUR & LARGEUR LÄNGE UND BREITE LONGITUD Y ANCHO ДЛИНА И ШИРИНА	BS EN ISO 10545-2	+/- 0.5%	+/- 0.3%
	THICKNESS SPESSORE ÉPAISSEUR STÄRKE GROSOR ТОЛЩИНА	BS EN ISO 10545-2	+/-10%	+/- 5.0%
	RECTANGLE SQUARENESS ORTOGONALITÀ RETTANGOLARE RECTANGULAIRE ÉQUERRAGE RECHTCKEIGEN RECHTWINKLIGKEIT CUADRATURA RECTANGULAR ПРЯМОУГОЛЬНОСТЬ	BS EN ISO 10545-2	+/- 0.5%	+/- 0.4%
	STRAIGHTNESS OF SIDES RETTILINEITÀ DEI LATI RECTITUDE DES CÔTÉS GERADHEIT DER SEITEN RECTITUD DE LOS LADOS ПРЯМОЛИНЕЙНОСТЬ СТОРОН	BS EN ISO 10545-2	+/- 0.5%	+/- 0.3%
	SURFACE FLATNESS PLANARITÀ DELLA SUPERFICIE PLANÉITÉ DE SURFACE OBERFLÄCHENEVENHEIT HORIZONTALIDAD DE LA SUPERFICIE ПЛОСКОСТЬ ПОВЕРХНОСТИ	BS EN ISO 10545-2	+/- 0.5%	+/- 0.3%
	WATER ABSORPTION ASSORBIMENTO DELL'ACQUA ABSORPTION D'EAU WASSERABSCHEIDUNG ABSORCIÓN DE AGUA ВОДОПОГЛОЩЕНИЕ	BS EN ISO 10545-3	10% < E <= 20%	10% <E <= 18%
	MODULUS OF RUPTURE MODULO DI ROTTURA MODULE DE RUPTURE BIEGEFESTIGKEIT MÓDULO DE ROTURA ПРОЧНОСТЬ НА ИЗЛОМ	BS EN ISO 10545-4		
	THICKNESS > = 7.5MM SPESSORE > = 7.5MM ÉPAISSEUR > = 7.5MM STÄRKE > = 7.5MM GROSOR > = 7.5MM ТОЛЩИНА > = 7.5MM		>=12 N/MM2	>=16 N/MM2
	THICKNESS < = 7.5MM SPESSORE < = 7.5MM ÉPAISSEUR < = 7.5MM STÄRKE < = 7.5MM GROSOR < = 7.5MM ТОЛЩИНА > = 7.5MM		>=15 N/MM2	>=16 N/MM2

Note : Shade variation across the batches is inherent to the manufacturing process and the pre-laying colour comparison is recommended.





Nota: Differenti lotti potrebbero essere soggetti a leggere variazioni di tonalità dipendenti dai differenti processi di produzione. Si raccomanda sempre di confrontare i colori prima della posa.

Note: La variation de l'ombre à travers les lots est inhérente au processus de fabrication et la comparaison de couleur avant la pose est recommandée.

Hinweis: Durch den Herstellungsprozess kann es zu Farbabweichungen kommen. Es wird ein vorheriger Farbvergleich empfohlen.

Nota: La variación de tonalidad a través de los lotes es inherente al proceso de fabricación y es recomendable una comparación previa del color.

Примечание: Производственному процессу свойственна вариация оттенков в зависимости от партии, в связи с чем перед укладкой рекомендуется провести цветовое сравнение.

	TEST DESCRIPTION DESCRIZIONE DEL TESTO DESCRIPTION D'ESSAI TESTBESCHREIBUNG DESCRIPCIÓN DE LA PRUEBA ОПИСАНИЕ ИСПЫТАНИЯ	STANDARD TEST METHOD METODO DI PROVA MÉTHODE D'ESSAI STANDARD STANDARD-TESTMETHODE MÉTODO DE PRUEBA ESTÁNDAR СТАНДАРТНЫЙ ИСПЫТАТЕЛЬНЫЙ МЕТОД	INTERNATIONAL STANDARD ISO 13006 REQUISITI PREVISTI DALLA NORMA ISO 13006 NORME INTERNATIONALE ISO 13006 INTERNATIONALER STANDARD ISO 13006 NORMA INTERNACIONAL ISO 13006 МЕЖДУНАРОДНЫЙ СТАНДАРТ ISO 13006	RAK CERAMICS SPECIFICATIONS RAK CERAMICS - SPECIFICHE SPÉCIFICATIONS RAK CERAMICS RAK CERAMICS SPEZIFIKATIONEN RAK CERAMICS ESPECIFICACIONES СПЕЦИФИКАЦИИ RAK CERAMICS
	BREAKING STRENGTH RESISTENZA ALLA ROTTURA RÉSISTANCE À LA RUPTURE BRUCHSTARKE RESISTENCIA DE ROTURA ПРОЧНОСТЬ НА РАЗРЫВ	BS EN ISO 10545-4		
	THICKNESS > = 7.5MM SPESSORE > = 7.5MM ÉPAISSEUR > = 7.5MM STÄRKE > = 7.5MM GROSOR > = 7.5MM ТОЛЩИНА > = 7.5MM		>=600N	>=650N
	THICKNESS < = 7.5MM SPESSORE < = 7.5MM ÉPAISSEUR < = 7.5MM STÄRKE < = 7.5MM GROSOR < = 7.5MM ТОЛЩИНА > = 7.5MM		>=200N	>=400N
	RESISTANCE TO SURFACE ABRASION RESISTENZA ALL'ABRAZIONE SUPERFICIALE RÉSISTANCE À L'ABRASION DE SURFACE RESISTENZ GEGEN OBERFLÄCHENABRIEB RESISTENCIA A LA ABRASIÓN SUPERFICIAL СТОЙКОСТЬ К ИСТИРАНИЮ ПОВЕРХНОСТИ	BS EN ISO 10545-7	MANUFACTURER TO STATE ABRASION CLASS CLASSE DI ABRASIONE INDICATA DAL PRODUTTORE LE FABRICANT DOIT INDIQUER LA CLASSE D'ABRASION HERSTELLER ZUR ANGABE DER ABRIEBKLASSE FABRICADO SEGÚN EL TIPO DE ABRASIÓN ESPECIFICADO ИЗГОТОВЛЕНО СОГЛАСНО КЛАССУ ИСТИРАНИЯ	CLASS 2 - 4 CLASSE 2-4 CLASSE 2 - 4 CLASSE 2 - 4 CLASE 2 - 4 КЛАСС 2 – 4
	RESISTANCE TO THERMAL SHOCK RESISTENZA AGLI SHOCK TERMICI RÉSISTANCE AUX CHOCS THERMIQUES RESISTENZ GEGEN THERMALSCHOCK RESISTENCIA AL CHOQUE TÉRMICO СТОЙКОСТЬ К ТЕПЛООВОМУ УДАРУ	BS EN ISO 10545-9	NO VISIBLE DEFECT NESSUN DIFETTO VISIBILE AUCUN DÉFAUT VISIBILE KEINE VISUELLEN DEFEKTE SIN DEFECTOS VISIBLES НЕТ ВИДИМЫХ ДЕФЕКТОВ	NO VISIBLE DEFECT NESSUN DIFETTO VISIBILE AUCUN DÉFAUT VISIBILE KEINE VISUELLEN DEFEKTE SIN DEFECTOS VISIBLES НЕТ ВИДИМЫХ ДЕФЕКТОВ
	CRAZING RESISTANCE RESISTENZA ALLA SCREPOLATURA RÉSISTANCE AUX CRAQUELURES SUPERFICIELLES HAARRISS-RESISTENZ RESISTENCIA AL AGRIETAMIENTO СТОЙКОСТЬ К КРАКЕЛЮРУ	BS EN ISO 10545-11	NO CRAZING NESSUNA SCREPOLATURA AUCUNE CRAQUELURE KEIN BRUCH SIN AGRIETAMIENTO НЕТ КРАКЕЛЮРА	NO CRAZING NESSUNA SCREPOLATURA AUCUNE CRAQUELURE KEIN BRUCH SIN AGRIETAMIENTO НЕТ КРАКЕЛЮРА
	RESISTANCE TO CHEMICALS RESISTENZA AGLI AGENTI CHIMICI RÉSISTANCE AUX PRODUITS CHIMIQUES RESISTENZ GEGEN CHEMIKALIEN RESISTENCIA A LOS PRODUCTOS QUÍMICOS СТОЙКОСТЬ К ХИМИЧЕСКИМ ВЕЩЕСТВАМ	BS EN ISO 10545-13	NO VISIBLE EFFECT NESSUN EFFETTO VISIBILE AUCUN EFFET VISIBILE KEINE VISUELLEN EFFEKTE SIN EFECTO VISIBLES ВИДИМОГО ВЛИЯНИЯ НЕТ	NO VISIBLE EFFECT NESSUN EFFETTO VISIBILE AUCUN EFFET VISIBILE KEINE VISUELLEN EFFEKTE SIN EFECTO VISIBLES ВИДИМОГО ВЛИЯНИЯ НЕТ
	RESISTANCE TO STAINS RESISTENZA ALLE MACCHIE RÉSISTANCE AUX TACHES RESISTENZ GEGEN FLECKEN RESISTENCIA A LAS MANCHAS СТОЙКОСТЬ К КРАСИТЕЛЯМ	BS EN ISO 10545-14	MANUFACTURER TO STATE CLASS CLASSE DI ABRASIONE LE FABRICANT DOIT INDIQUER LA CLASSE HERSTELLER ZUR ANGABE DER KLASSE FABRICADO SEGÚN LO ESPECIFICADO ИЗГОТОВЛЕНО СОГЛАСНО КЛАССУ	STAIN REMOVED MIN. CLASS 4 RIMOZIONE DELLE MACCHIE MIN. CLASSE 4 ELIMINATION DES TACHES MIN. CLASSE 4 FLECKENENTFERNUNG MIN. CLASSE 4 MIN. REMOCIÓN DE MANCHAS. CLASE 4 ПЯТНО УДАЛЕНО МИН. КЛАСС 4
	SCRATCH HARDNESS : (MOH'S) INDICE DI DUREZZA (MOH'S) DIURETÉ À LA RAYURE : (MOH'S) RITZHÄRTE : (MOH'S) DUREZA AL RAYADO: (MOH'S)	EN 101		4 - 6

TECHNICAL CHARACTERISTICS - GRES WHITE BODY TILES (BIIA)







CARATTERISTICHE TECNICHE - MONOCOTTURA A PASTA BIANCA (BIIA)

CARACTÉRISTIQUES TECHNIQUES - MONOCUISSON EN PÂTE BLANCHE (BIIA)

TECHNISCHE EIGENSCHAFTEN - WEISSES, GLASIERTES STEINZEUG (BIIA)

CARACTERÍSTICAS TÉCNICAS - MONOCOCCION DE PASTA BLANCA (BIIA)

ТЕХНИЧЕСКИЕ ХАРАКТЕРИСТИКИ - ПЛИТКА ИЗ КЕРАМИЧЕСКОГО ГРАНИТА БЕЛОЕ ТЕЛО БЕЛОЕ ТЕЛО (BIIA)

	TEST DESCRIPTION DESCRIZIONE DEL TESTO DESCRIPTION D'ESSAI TESTBESCHREIBUNG DESCRIPCIÓN DE LA PRUEBA ОПИСАНИЕ ИСПЫТАНИЯ	STANDARD TEST METHOD METODO DI PROVA MÉTHODE D'ESSAI STANDARD STANDARD-TESTMETHODE MÉTODO DE PRUEBA ESTÁNDAR СТАНДАРТНЫЙ ИСПЫТАТЕЛЬНЫЙ МЕТОД	INTERNATIONAL STANDARD ISO 13006 REQUISITI PREVISTI DALLA NORMA ISO 13006 NORME INTERNATIONALE ISO 13006 INTERNATIONALER STANDARD ISO 13006 NORMA INTERNACIONAL ISO 13006 МЕЖДУНАРОДНЫЙ СТАНДАРТ ISO 13006	RAK CERAMICS SPECIFICATIONS RAK CERAMICS - SPECIFICHE SPÉCIFICATIONS RAK CERAMICS RAK CERAMICS SPEZIFIKATIONEN RAK CERAMICS ESPECIFICACIONES СПЕЦИФИКАЦИИ RAK CERAMICS
	LENGTH & WIDTH LUNGHEZZA & LARGHEZZA LONGUEUR & LARGEUR LÄNGE UND BREITE LONGITUD Y ANCHO ДЛИНА И ШИРИНА	BS EN ISO 10545-2	+/- 0.6%	+/- 0.3%
	THICKNESS SPESSORE ÉPAISSEUR STÄRKE GROSOR ТОЛЩИНА	BS EN ISO 10545-2	+/- 0.5%	+/- 5.0%
	RECTANGLE SQUARENESS ORTOGONALITÀ RETTANGOLARE RECTANGULAIRE ÉQUERRAGE RECHTECKIGEN RECHTWINKLIGKEIT CUADRATURA RECTANGULAR ПРЯМОУГОЛЬНОСТЬ	BS EN ISO 10545-2	+/- 0.5%	+/- 0.4%
	STRAIGHTNESS OF SIDES RETTILINEITÀ DEI LATI RECTITUDE DES CÔTÉS GERADHEIT DER SEITEN RECTITUD DE LOS LADOS ПРЯМОЛИНЕЙНОСТЬ СТОРОН	BS EN ISO 10545-2	+/- 0.5%	+/- 0.3%
	SURFACE FLATNESS PLANARITÀ DELLA SUPERFICIE PLANÉITÉ DE SURFACE OBERFLÄCHENEVENHEIT HORIZONTALIDAD DE LA SUPERFICIE ПЛОСКОСТЬ ПОВЕРХНОСТИ	BS EN ISO 10545-2	+/- 0.5%	+/- 0.4%
	WATER ABSORPTION ASSORBIMENTO DELL'ACQUA ABSORPTION D'EAU WASSERABSCHEIDUNG ABSORCIÓN DE AGUA ВОДОПОГЛОЩЕНИЕ	BS EN ISO 10545-3	3% < E <= 6%	3% < E <= 5%
	MODULUS OF RUPTURE MODULO DI ROTTURA MODULE DE RUPTURE BIEGEFESTIGKEIT MÓDULO DE ROTURA ПРОЧНОСТЬ НА ИЗЛОМ	BS EN ISO 10545-4	>=22 N/MM2	>=30 N/MM2

	TEST DESCRIPTION DESCRIZIONE DEL TESTO DESCRIPTION D'ESSAI TESTBESCHREIBUNG DESCRIPCIÓN DE LA PRUEBA ОПИСАНИЕ ИСПЫТАНИЯ	STANDARD TEST METHOD METODO DI PROVA MÉTHODE D'ESSAI STANDARD STANDARD-TESTMETHODE MÉTODO DE PRUEBA ESTÁNDAR СТАНДАРТНЫЙ ИСПЫТАТЕЛЬНЫЙ МЕТОД	INTERNATIONAL STANDARD ISO 13006 REQUISITI PREVISTI DALLA NORMA ISO 13006 NORME INTERNATIONALE ISO 13006 INTERNATIONALER STANDARD ISO 13006 NORMA INTERNACIONAL ISO 13006 МЕЖДУНАРОДНЫЙ СТАНДАРТ ISO 13006	RAK CERAMICS SPECIFICATIONS RAK CERAMICS - SPECIFICHE SPÉCIFICATIONS RAK CERAMICS RAK CERAMICS SPEZIFIKATIONEN RAK CERAMICS ESPECIFICACIONES СПЕЦИФИКАЦИИ RAK CERAMICS
	BREAKING STRENGTH RESISTENZA ALLA ROTTURA RÉSISTANCE À LA RUPTURE BRUCHSTÄRKE RESISTENCIA DE ROTURA ПРОЧНОСТЬ НА РАЗРЫВ	BS EN ISO 10545-4		
	THICKNESS > = 7.5MM SPESSORE > = 7.5MM ÉPAISSEUR > = 7.5MM STÄRKE > = 7.5MM GROSOR > = 7.5MM ТОЛЩИНА > = 7.5MM		>=1000N	>=1100N
	THICKNESS < = 7.5MM SPESSORE < = 7.5MM ÉPAISSEUR < = 7.5MM STÄRKE < = 7.5MM GROSOR < = 7.5MM ТОЛЩИНА > = 7.5MM		>=600N	>=800N
	RESISTANCE TO SURFACE ABRASION RESISTENZA ALL'ABRASIONE SUPERFICIALE RÉSISTANCE À L'ABRASION DE SURFACE RESISTENZ GEGEN OBERFLÄCHENABRIEB RESISTENCIA A LA ABRASIÓN SUPERFICIAL СТОЙКОСТЬ К ИСТИРАНИЮ ПОВЕРХНОСТИ	BS EN ISO 10545-7	MANUFACTURER TO STATE ABRASION CLASS CLASSE DI ABRASIONE INDICATA DAL PRODUTTORE LE FABRICANT DOIT INDIQUER LA CLASSE D'ABRASION HERSTELLER ZUR ANGABE DER ABRIEBKLASSE FABRICADO SEGÚN EL TIPO DE ABRASIÓN ESPECIFICADO ИЗГОТОВЛЕНО СОГЛАСНО КЛАССУ ИСТИРАНИЯ	CLASS 2 - 4 CLASSE 2-4 CLASSE 2 - 4 CLASSE 2 - 4 CLASSE 2 - 4 КЛАСС 2 – 4
	RESISTANCE TO THERMAL SHOCK RESISTENZA AGLI SHOCK TERMICI RÉSISTANCE AUX CHOCS THERMIQUES RESISTENZ GEGEN THERMALSCHOCK RESISTENCIA AL CHOQUE TÉRMICO СТОЙКОСТЬ К ТЕПЛОВОМУ УДАРУ	BS EN ISO 10545-9	NO VISIBLE DEFECT NESSUN DIFETTO VISIBILE AUCUN DÉFAUT VISIBILE KEINE VISUELLEN DEFEKTE SIN DEFECTOS VISIBLES НЕТ ВИДИМЫХ ДЕФЕКТОВ	NO VISIBLE DEFECT NESSUN DIFETTO VISIBILE AUCUN DÉFAUT VISIBILE KEINE VISUELLEN DEFEKTE SIN DEFECTOS VISIBLES НЕТ ВИДИМЫХ ДЕФЕКТОВ
	CRAZING RESISTANCE RESISTENZA ALLA SCREPOLATURA RÉSISTANCE AUX CRAQUELURES SUPERFICIELLES HAARRISS-RESISTENZ RESISTENCIA AL AGRIETAMIENTO СТОЙКОСТЬ К КРАКЕЛЮРУ	BS EN ISO 10545-11	NO CRAZING NESSUNA SCREPOLATURA AUCUNE CRAQUELURE KEIN BRUCH SIN AGRIETAMIENTO НЕТ КРАКЕЛЮРА	NO CRAZING NESSUNA SCREPOLATURA AUCUNE CRAQUELURE KEIN BRUCH SIN AGRIETAMIENTO НЕТ КРАКЕЛЮРА
	RESISTANCE TO CHEMICALS RESISTENZA AGLI AGENTI CHIMICI RÉSISTANCE AUX PRODUITS CHIMIQUES RESISTENZ GEGEN CHEMIKALIEN RESISTENCIA A LOS PRODUCTOS QUÍMICOS СТОЙКОСТЬ К ХИМИЧЕСКИМ ВЕЩЕСТВАМ	BS EN ISO 10545-13	NO VISIBLE EFFECT NESSUN EFFETTO VISIBILE AUCUN EFFET VISIBILE KEINE VISUELLEN EFFEKT SIN EFECTO VISIBLES ВИДИМОГО ВЛИЯНИЯ НЕТ	NO VISIBLE EFFECT NESSUN EFFETTO VISIBILE AUCUN EFFET VISIBILE KEINE VISUELLEN EFFEKT SIN EFECTO VISIBLES ВИДИМОГО ВЛИЯНИЯ НЕТ
	RESISTANCE TO STAINS RESISTENZA ALLE MACCHIE RÉSISTANCE AUX TACHES RESISTENZ GEGEN FLECKEN RESISTENCIA A LAS MANCHAS СТОЙКОСТЬ К КРАСИТЕЛЯМ	BS EN ISO 10545-14	MANUFACTURER TO STATE CLASS CLASSE DI ABRASIONE LE FABRICANT DOIT INDIQUER LA CLASSE HERSTELLER ZUR ANGABE DER KLASSE FABRICADO SEGÚN LO ESPECIFICADO ИЗГОТОВЛЕНО СОГЛАСНО КЛАССУ	STAIN REMOVED MIN. CLASS 4 RIMOZIONE DELLE MACCHIE MIN. CLASSE 4 ELIMINATION DES TACHES MIN. CLASSE 4 FLECKENENTFERNUNG MIN. CLASSE 4 MIN. REMOCIÓN DE MANCHAS. CLASE 4 ПЯТНО УДАЛЕНО МИН. КЛАСС 4
	SCRATCH HARDNESS : (MOH'S) INDICE DI DUREZZA (MOH'S) DIURETÉ À LA RAYURE : (MOH'S) RITZHÄRTE : (MOH'S) DUREZA AL RAYADO : (MOH'S)	EN 101	-	4 - 6

Note : Shade variation across the batches is inherent to the manufacturing process and the pre-laying colour comparison is recommended.

Nota: Differenti lotti potrebbero essere soggetti a leggere variazioni di tonalità dipendenti dai differenti processi di produzione. Si raccomanda sempre di confrontare i colori prima della posa.

Note: La variation de l'ombre à travers les lots est inhérente au processus de fabrication et la comparaison de couleur avant la pose est recommandée.

Hinweis: Durch den Herstellungsprozess kann es zu Farbabweichungen kommen. Es wird ein vorheriger Farbvergleich empfohlen.

Nota: La variación de tonalidad a través de los lotes es inherente al proceso de fabricación y es recomendable una comparación previa del color.

Примечание: Производственному процессу свойственна вариация оттенков в зависимости от партии, в связи с чем перед укладкой рекомендуется провести цветное сравнение.

TECHNICAL FEATURES

CARATTERISTICHE TECNICHE | CARACTÉRISTIQUES TECHNIQUES | TECHNISCHE EIGENSCHAFTEN |

CARACTERÍSTICAS TÉCNICAS | ТЕХНИЧЕСКИЕ ОСОБЕННОСТИ

Porcelain tiles in a variety of colors and finishes

PORCELAIN TILES (BIA - GL) :

Porcelain tiles are manufactured using pure, selectively imported raw materials mixed using the most advanced extraction and sorting techniques; they are obtained with a production process similar to that of single-fired tiles.

The resulting product is top-quality porcelain tile, obtained by raw materials wet grinding, followed by partial drying by spraying, silo storage to allow homogenization of properties, and pressing with highly efficient hydraulic presses up to specific pressures more than 500 kg/cm2. The high pressure combined with high firing temperature exceeding 1200 °C results in highly compact & strong ceramic surface with very low water absorption (lower than 0.4% according to UNI EN ISO 10545-3) and extremely high mechanical resistance (average value exceeding 40 N/mm2 according to UNI EN ISO 10545-4).

Thanks to their low porosity, these porcelain tiles are frost-proof and rated as belonging to the Bia GL class according to the International Standard ISO 13006 and European Standard UNI EN 14411 which requires water absorption ≤ 0.5%.

The MoR (modulus of rupture) in accordance with UNI EN ISO 10545-4 results to 40 N/mm2 while the required value is 35 N/mm2. RAK Ceramics porcelain tiles are available in a wide range of designs, sizes and finishes.

Porcelain tiles in a variety of colors and finishes

ADVICE ON LAYING

Although our porcelain tiles can be installed using traditional cement mortars, we advise using modern adhesives. While installing on wall, the two-layer spreading system is recommended to perfectly wet the back of the tile.

Quickly dipping each tile in water before installation will remove any dust on the back of the tile for perfect adhesion. Do not wet the tiles if you are using vinyl, acrylic resin adhesives or two-component organic-solvent based adhesive.

It is advisable to incorporate suitable shrinkage - flexion joints (movement/ expansion joints) when installing on large floors: the joints should never be spaced more than 4 - 5 linear meters apart indoors and 3 linear meters apart outdoors. Be careful while using strong coloured grouts as they might leave stains on the surface of the tiles that may be difficult to remove later.

Porcelain tiles in a variety of colors and finishes

GRES PORCELLANATO (BIA - GL) :

Le piastrelle in gres porcellanato vengono prodotte utilizzando materie prime d’importazione pure e selezionate, miscelate utilizzando le tecniche di estrazione e selezione più avanzate; esse sono prodotte inoltre con un processo simile a quello utilizzato per le piastrelle in monocottura.

Le materie prime vengono sottoposte ad un processo di macinazione ad umido, seguito da essiccazione a spruzzo parziale, stoccaggio in silos per consentirne l’omogeneizzazione, quindi la miscela viene pressata mediante presse idrauliche ad alta efficienza fino a pressioni specifiche superiori a 500 kg/cm2. L’alta pressione, insieme all’alta temperatura di cottura, superiore ai 1200°C, produce una superficie ceramica molto compatta e resistente, con un rapporto di assorbimento dell’acqua molto basso (inferiore allo 0,4%, conformemente allo standard UNI EN ISO 10545-3) e una resistenza meccanica estremamente alta (valore medio superiore a 40 N/mm2, conformemente allo standard UNI EN ISO 10545-4).

Grazie alla loro bassa porosità, queste piastrelle sono a prova di congelamento e classificate nel gruppo Bia GL in base allo standard europeo UNI EN 14411, che richiede un livello di assorbimento dell’acqua ≤ 0,5%.

Il modulo di rottura (MoR), conforme allo standard UNI EN ISO 10545-4, è di 40 N/mm2, contro un requisito minimo di 35 N/mm2. Le piastrelle porcellanate della RAK Ceramics sono disponibili in un’ampia gamma di forme, dimensioni e finiture.

Porcelain tiles in a variety of colors and finishes

CONSIGLI PER LA POSA

Anche se le nostre piastrelle di gres porcellanato possono essere posate mediante malte cementizie tradizionali, consigliamo gli adesivi moderni. Quando si posa su parete, si raccomanda il sistema di spargimento a due strati per bagnare perfettamente il retro della piastrella.

Immergere rapidamente in acqua ciascuna piastrella prima della posa servirà a rimuovere la polvere dal retro della piastrella al fine di una perfetta adesione; tuttavia, non bagnare le piastrelle quando si usano adesivi a base di resine acriliche o viniliche o adesivi a base di solventi organici a due componenti.

Quando si posa su pavimenti di ampie dimensioni è consigliabile incorporare idonei giunti di ritiro-flessione (giunti di movimento/espansione) che non devono essere distanziati più di 4-5 metri l’uno dall’altro negli ambienti interni o 3 metri lineari negli ambienti esterni. Prestare attenzione quando si usano stucchi molto colorati, poiché potrebbero lasciare sulla superficie delle piastrelle macchie che potrebbero risultare difficili da rimuovere in seguito.

Porcelain tiles in a variety of colors and finishes

CARREAUX EN GRÈS CÉRAME (BIA - GL) :

Les carreaux en grès cérame sont fabriqués à partir de matières premières pures sélectivement importées, mélangées à l’aide des techniques d’extraction et de tri des plus sophistiquées ; et leur fabrication nécessite un processus de production identique à celui des carreaux en monocuisson.

Les matières premières entament un processus de broyage humide suivi du séchage partiel par pulvérisation, du silotage pour assurer l’homogénéisation, puis le mélange est pressé grâce à des presses hydrauliques haute efficacité à une puissance de pressage spécifique de plus de 500 kg/cm2. Combinée à une température de cuisson élevée excédant 1200°C, la forte pression entraîne une surface céramique très compacte et solide à faible taux d’absorption d’eau (inférieur à 0,4% selon la norme UNI EN ISO 10545-3) et d’une résistance mécanique extrêmement élevée (valeur moyenne dépassant 40 N/mm2 selon la norme UNI EN ISO 10545-4).

Grâce à leur faible porosité, ces carreaux en grès cérame émaillés résistent au gel et sont classés dans le groupe Bia GL conformément à la norme européenne UNI EN 14411 exigeant un taux d’absorption d’eau ≤ 0,5%.

. Le module de rupture (MoR) conformément à la norme UNI EN ISO 10545-4 est de 40 N/mm2, alors que la valeur requise est de 35 N/mm2. Les carreaux en grès cérame émaillés de RAK Ceramics sont disponibles dans un large éventail de modèles, tailles et finitions.

RECOMMANDATIONS EN MATIÈRE DE POSE

Bien que nos carreaux en grès de cérame peuvent être posés à l’aide de mortiers de ciment traditionnels, nous recommandons l’utilisation de colles modernes. Lors de la pose sur des murs, le système d’épandage bi-couches est recommandé pour bien humidifier l’envers du carreau.

Pour une meilleure adhésion, il est possible de plonger de manière rapide chaque carreau dans l’eau avant la pose. Cependant, évitez de mouiller les carreaux en cas d’utilisation de colles à base de résine acrylique ou vinilyque ou en cas d’utilisation de colle à base de solvant organique bi-composants.

Il est recommandé d’utiliser des joints de retrait-flexion (joints de mouvement/dilatation) lors de la pose sur des grandes surfaces : les joints ne doivent jamais être espacés l’un de l’autre de plus de 4 à 5 mètres linéaires à l’intérieur et de 3 mètres linéaires à l’extérieur. Faites preuve de prudence en cas d’utilisation de coulis colorés solides, lesquels peuvent laisser, sur la surface des carreaux, des taches qui peuvent être difficiles à éliminer plus tard.

Porcelain tiles in a variety of colors and finishes

FEINSTEINZEUG (BIA - GL) :

Feinsteinzeug wird aus reinen, ausgewählten Rohstoffen hergestellt und mit modernsten Extraktionsverfahren und Sortiertechniken gemischt. Sie werden in einem ähnlichen Prozess wie die Einbrandfliesen hergestellt.

Die Rohmaterialien werden einem Nassmahlverfahren, gefolgt von teilweiser Sprühtrocknung unterzogen und zur Homogenisierung in Silos gelagert. Danach wird die Mischung mit hocheffizienten hydraulischen Pressen bei spezifischen Drücken von bis zu mehr als 500 kg/cm2 gepresst. Durch den hohen Druck in Kombination mit der hohen Brenntemperatur von über 1200°C entsteht eine sehr kompakte und starke keramische Oberfläche mit einer sehr geringen Wasseraufnahme (weniger als 0,4% nach UNI EN ISO 10545-3) und extrem hoher mechanischer Beständigkeit (Mittelwert von mehr als 40 N/mm2 nach UNI EN ISO 10545-4).

Dank der geringen Porosität sind diese Fliesen frostsicher und entsprechend der europäischen Norm UNI EN 14411, die eine Wasseraufnahme von ≤ 0,5% fordert, als Bia GL-Klasse bewertet.

Die Biegefestigkeit gemäß UNI EN ISO 10545-4 beträgt 40 N/mm2, während der benötigte Wert 35 N/mm2 beträgt. Die Porzellanfliesen von RAK Ceramics sind in einer Vielzahl an Designs, Größen und Ausführungen erhältlich.

TIPPS ZUR VERLEGUNG

Obwohl unsere Feinsteinzeug mit herkömmlichen Zementmörtel verlegt werden kann empfehlen wir den Einsatz moderner Klebstoffe. Beim Verlegen auf Wänden wird zur perfekten Benetzung der Rückseite der Fliesen das Zweischicht-Streusystem empfohlen.

Durch ein schnelles Eintauchen der Fliese in Wasser direkt vor dem Auslegen wird der Staub auf der Rückseite dieser entfernt und eine perfekte Haftung garantiert. Befeuchten Sie Fliesen allerdings nicht, wenn Sie Vinyl- oder Acrylharzklebstoffe oder Zweikomponentenkleber verwenden, die auf organischen Lösungsmitteln basieren.

Beim Verlegen großer Flächen wird empfohlen, geeignete Schrumpfgelenkfugen (Bewegungsfugen/Dehnfugen) zu verwenden, die nicht bei der Verlegung im Inneren nicht weiter als 4-5 Laufmeter und bei Verlegung im Äußeren nicht weiter als 3 Laufmeter von einander entfernt sein dürfen. Seien Sie bei der Verwendung von stark farbigem Mörtel vorsichtig, da dieser Flecken auf der Oberfläche der Fliese hinterlassen kann, die später schwierig zu entfernen sind.

Porcelain tiles in a variety of colors and finishes

PORCELÁNICO (BIA - GL) :

Los azulejos de porcelánico son elaborados utilizando material prima pura, importada selectivamente, mezclada utilizando las técnicas de extracción y clasificación más avanzadas; y son fabricados utilizando un proceso similar al utilizado con azulejos de cocción simple.

La materia prima pasa por un proceso de amolado húmedo, seguido por secado parcial con rociador, almacenamiento en silos para permitir la homogenización, y después la mezcla es prensada utilizando prensas hidráulicas de alta eficacia, que los lleva a presiones específicas de más de 500 kg/cm2. La alta presión combinada con una temperatura de cocción de más de 1200 °C resulta en una superficie cerámica altamente compacta y fuerte con poca absorción de agua (menor a 0.4% de acuerdo a la norma UNI EN ISO 10545-3) y resistencia mecánica extremadamente alta (el valor promedio sobrepasando 40 N/mm2 de acuerdo a la norma UNI EN ISO 10545-4).

Gracias a su baja porosidad, estos azulejos de porcelánico son a prueba de escarcha y calificados como pertenecientes a la clase Bia GL de acuerdo a la norma europea UNI EN 14411 la cual requiere absorción de agua ≤ 0.5%.

El módulo de ruptura (MoR) de acuerdo con UNI EN ISO 10545-4 es 40 N/mm2 mientras el valor requerido es de 35 N/mm2. Los azulejos de porcelánico esmaltado de RAK Ceramics están disponibles en una ancha gama de diseños, tamaños y acabados.

Porcelain tiles in a variety of colors and finishes

SUGERENCIAS PARA SU COLOCACION

Aunque nuestros azulejos de porcelánico pueden ser instalados utilizando morteros de cemento tradicionales, sugerimos utilizar adhesivos modernos. Al instalarlo en paredes, se recomienda el sistema de distribución de dos capas para humedecer perfectamente la parte posterior del azulejo.

El baño rápidamente cada azulejo en agua antes de la instalación eliminará cualquier cantidad de polvo de la parte trasera del azulejo para una adhesión perfecta; sin embargo, no moje los azulejos si está utilizando vinil, adhesivos de resina de acrílico o adhesivo con base de solvente orgánico de dos componentes.

Se recomienda siempre incorporar juntas de dilatación -contracción (juntas de movimiento y expansión) apropiadas al instalar sobre pisos extensos: las juntas nunca deben ser colocadas a más de 4 o 5 metros lineales de espacio entre ellas en el interior, y 3 metros lineales de espacio entre ellas en el exterior. Tenga cuidado al utilizar lechada de color ya que pueden dejar manchas sobre la superficie de los azulejos que pueden ser difíciles de eliminar después.

Porcelain tiles in a variety of colors and finishes

ПЛИТКА ИЗ КЕРАМИЧЕСКОГО ГРАНИТА БЕЛОЕ ТЕЛО

Плитка из керамического гранита белое тело изготавливается из чистого, отборного сырья с использованием самых современных технологий экстракции и сортировки; она производится в процессе, аналогичном процессу для плитки однократного обжига.

Конечный продукт представляет собой высококачественную Плитка из керамического гранита белое тело , получаемую путем мокрого измельчения сырья с последующей частичной сушкой путем распыления, башенного хранения для гомогенизации свойств и прессования на высокоэффективных гидравлических прессах под давлением выше 500 кг/см2. Высокое давление в сочетании с высокой температурой обжига, превышающей 1200°C, создает чрезвычайно компактную и прочную керамическую поверхность с очень низким водопоглощением (менее 0,4% согласно UNI EN ISO 10545-3) и крайне высокой механической прочностью (среднее значение выше 50 Н/мм2 согласно UNI EN ISO10545-4).

Благодаря низкой пористости эта плитка является морозостойкой и классифицируется как класс Bia GL согласно Европейскому стандарту UNI EN 14411, требующему водопоглощения ≤ 0.5%.

Предел модуля излома в соответствии с UNI EN ISO 10545-4 составляет 40 Н/мм2, при требуемом значении 35 Н/мм2. Плитка из керамического гранита белое тело компании RAK Ceramics доступна в широком ассортименте дизайна, размеров и отделки.

Porcelain tiles in a variety of colors and finishes

СОВЕТ ПО УКЛАДКЕ

Хотя наша Плитка из керамического гранита белое тело может устанавливаться с использованием традиционных цементных растворов, мы рекомендуем использовать современные клеи. При установке на стену, для хорошего смачивания тыльной стороны плитки, мы рекомендуем использовать двухслойную систему нанесения клея.

Быстрое погружение каждой плитки в воду перед установкой удаляет пыль с тыльной стороны плитки для лучшего приклеивания. Не смачивайте плитку перед укладкой при использовании клея на основе акриловой или виниловой смолы либо клея на основе двухкомпонентного органического растворителя.

При укладке на большие площади рекомендуется применять усадочные швы (деформационные/компенсационные швы), расположенные на расстоянии не более 4-5 погонных метров друг от друга внутри помещений и 3 погонных метров друг от друга при укладке вне помещений. Будьте осторожны при использовании сильно окрашенных подливок, так как они могут оставлять пятна на поверхности плитки, которые может быть трудно удалить в последствии.

TECHNICAL CHARACTERISTICS - PORCELAIN TILES (BIA - GL)









CARATTERISTICHE TECNICHE - GRES PORCELLANATO (BIA - GL)

CARACTÉRISTIQUES TECHNIQUES - GRÈS CÉRAMÉ (BIA - GL)

TECHNISCHE EIGENSCHAFTEN - FEINSTEINZEUG (BIA - GL)

CARACTERÍSTICAS TÉCNICAS - GRES PORCELÁNICO (BIA - GL)

ТЕХНИЧЕСКИЕ ХАРАКТЕРИСТИКИ - ПЛИТКА ИЗ КЕРАМИЧЕСКОГО ГРАНИТА БЕЛОЕ ТЕЛО (BIA - GL)

	TEST DESCRIPTION DESCRIZIONE DEL TESTO DESCRIPTION D'ESSAI TESTBESCHREIBUNG DESCRIPCIÓN DE LA PRUEBA ОПИСАНИЕ ИСПЫТАНИЯ	STANDARD TEST METHOD MÉTODO DI PROVA MÉTHODE D'ESSAI STANDARD STANDARD-TESTMETHODE MÉTODO DE PRUEBA ESTÁNDAR СТАНДАРТНЫЙ ИСПЫТАТЕЛЬНЫЙ МЕТОД	INTERNATIONAL STANDARD ISO 13006 REQUISITI PREVISTI DALLA NORMA ISO 13006 NORME INTERNATIONALE ISO 13006 INTERNATIONALER STANDARD ISO 13006 NORMA INTERNACIONAL ISO 13006 МЕЖДУНАРОДНЫЙ СТАНДАРТ ISO 13006	RAK CERAMICS SPECIFICATIONS RAK CERAMICS - SPECIFICHE SPÉCIFICATIONS RAK CERAMICS RAK CERAMICS SPEZIFIKATIONEN RAK CERAMICS ESPECIFICACIONES СПЕЦИФИКАЦИИ RAK CERAMICS	
				(Rectified) (Rettificato) (Rectifié) (Berichtigt) (Rectificado) Ректифицированная	(Unrectified) (Non rettificato) Non rectifié) (Unberichtigt) (No rectificado) Неректифицированная
	LENGTH & WIDTH LUNGHEZZA LARGHEZZA LONGUEUR & LARGEUR LÄNGE UND BREITE LONGITUD Y ANCHO ДЛИНА И ШИРИНА	BS EN ISO 10545-2	+/- 0.6%	+/- 0.1%	+/- 0.3%
	THICKNESS SPESSORE ÉPAISSEUR STÄRKE GROSOR ТОЛЩИНА	BS EN ISO 10545-2	+/- 5.0%	+/- 5.0%	+/- 5.0%
	RECTANGLE SQUARENESS ORTOGONALITÀ RETTANGOLARE RECTANGULAIRE ÉQUERRAGE RECHTECKIGEN RECHTWINKLIGKEIT CUADRATURA RECTANGULAR ПРЯМОУГОЛЬНОСТЬ	BS EN ISO 10545-2	+/- 0.5%	+/- 0.2%	+/- 0.4%
	STRAIGHTNESS OF SIDES RETTILINEITÀ DEI LATI RECTITUDE DES CÔTÉS GERADHEIT DER SEITEN RECTITUD DE LOS LADOS ПРЯМОЛИНЕЙНОСТЬ СТОРОН	BS EN ISO 10545-2	+/- 0.5%	+/- 0.2%	+/- 0.3%
	SURFACE FLATNESS PLANARITÀ DELLA SUPERFICIE PLANÉITÉ DE SURFACE OBERFLÄCHENEVENHEIT HORIZONTALIDAD DE LA SUPERFICIE ПЛОСКОСТЬ ПОВЕРХНОСТИ	BS EN ISO 10545-2	+/- 0.5%	+/- 0.3%	+/- 0.3%
	WATER ABSORPTION ASSORBIMENTO DELL'ACQUA ABSORPTION D'EAU WASSERABSCHEIDUNG ABSORCIÓN DE AGUA ВОДОПОГЛОЩЕНИЕ	BS EN ISO 10545-3	<= 0.5%	<= 0.4%	<= 0.4%
	MODULUS OF RUPTURE MODULO DI ROTTURA MODULE DE RUPTURE BIEGEFESTIGKEIT MÓDULO DE ROTURA ПРОЧНОСТЬ НА ИЗЛОМ	BS EN ISO 10545-4	>=35 N/MM2	>=40 N/MM2	>=40 N/MM2
	BREAKING STRENGTH RESISTENZA ALLA ROTTURA RÉSISTANCE À LA RUPTURE BRUCHSTÄRKE RESISTENCIA DE ROTURA ПРОЧНОСТЬ НА РАЗРЫВ	BS EN ISO 10545-4	>=1300N	>=1600N	>=1600N

Note : Shade variation across the batches is inherent to the manufacturing process and the pre-laying colour comparison is recommended.









Nota: Differenti lotti potrebbero essere soggetti a leggere variazioni di tonalità' dipendenti dai differenti processi di produzione. Si raccomanda sempre di confrontare i colori prima della posa.

Note: La variation de l'ombre à travers les lots est inhérente au processus de fabrication et la comparaison de couleur avant la pose est recommandée.

Hinweis: Durch den Herstellungsprozess kann es zu Farbabweichungen kommen. Es wird ein vorheriger Farbvergleich empfohlen.

Nota: La variación de tonalidad a través de los lotes es inherente al proceso de fabricación y es recomendable una comparación previa del color.

Примечание: Производственному процессу свойственна вариация оттенков в зависимости от партии, в связи с чем перед укладкой рекомендуется провести цветное сравнение.

	TEST DESCRIPTION DESCRIZIONE DEL TESTO DESCRIPTION D'ESSAI TESTBESCHREIBUNG DESCRIPCIÓN DE LA PRUEBA ОПИСАНИЕ ИСПЫТАНИЯ	STANDARD TEST METHOD MÉTODO DI PROVA MÉTHODE D'ESSAI STANDARD-TESTMETHODE MÉTODO DE PRUEBA ESTÁNDAR СТАНДАРТНЫЙ ИСПЫТАТЕЛЬНЫЙ МЕТОД	INTERNATIONAL STANDARD ISO 13006 REQUISITI PREVISTI DALLA NORMA ISO 13006 NORME INTERNATIONALE ISO 13006 INTERNATIONALER STANDARD ISO 13006 NORMA INTERNACIONAL ISO 13006 МЕЖДУНАРОДНЫЙ СТАНДАРТ ISO 13006	RAK CERAMICS SPECIFICATIONS RAK CERAMICS - SPECIFICHE SPÉCIFICATIONS RAK CERAMICS RAK CERAMICS SPEZIFIKATIONEN RAK CERAMICS ESPECIFICACIONES СПЕЦИФИКАЦИИ RAK CERAMICS	
				(Rectified) (Rettificato) (Rectifié) (Berichtigt) (Rectificado) Ректифицированная	(Unrectified) (Non rettificato) Non rectifié) (Unberichtigt) (No rectificado) Неректифицированная
	RESISTANCE TO SURFACE ABRASION RESISTENZA ALL'ABRASIONE SUPERFICIALE RÉSISTANCE À L'ABRASION DE SURFACE RESISTENZ GEGEN OBERFLÄCHENABRIEB RESISTENCIA A LA ABRASIÓN SUPERFICIAL СТОЙКОСТЬ К ИСТИРАНИЮ ПОВЕРХНОСТИ	BS EN ISO 10545-7			
	LINEAR THERMAL EXPANSION DILATAZIONE TERMICA LINEARE DILATATION THERMIQUE LINÉAIRE LINEARE WÄRMEAUSSDEHNUNG EXPANSION TÉRMICA LINEAL ЛИНЕЙНОЕ ТЕРМИЧЕСКОЕ РАСШИРЕНИЕ	BS EN ISO 10545-8	<=9x10 ⁻⁶ /C°	<=7x10 ⁻⁶ /C°	<=7x10 ⁻⁶ /C°
	RESISTANCE TO THERMAL SHOCK RESISTENZA AGLI SHOCK TERMICI RÉSISTANCE AUX CHocs THERMIQUES RESISTENZ GEGEN THERMALSCHOCK RESISTENCIA AL CHOQUE TÉRMICO СТОЙКОСТЬ К ТЕПЛОВОМУ УДАРУ	BS EN ISO 10545-9			
	CRAZING RESISTANCE RESISTENZA ALLA SCREPOLATURA RÉSISTANCE AUX CRAQUELURES SUPERFICIELLES HAARRISS-RESISTENZ RESISTENCIA AL AGRIETAMIENTO СТОЙКОСТЬ К КРАКЕЛЮРУ	BS EN ISO 10545-11			
	FROST RESISTANCE RESISTENZA AL GELO RÉSISTANCE AU GEL FROST-RESISTENZ RESISTENCIA A LA CONGELACIÓN МОРОЗОСТОЙКОСТЬ	BS EN ISO 10545-12			
	RESISTANCE TO CHEMICALS RESISTENZA AGLI AGENTI CHIMICI RÉSISTANCE AUX PRODUITS CHIMIQUES RESISTENZ GEGEN CHEMIKALIEN RESISTENCIA A LOS PRODUCTOS QUÍMICOS СТОЙКОСТЬ К ХИМИЧЕСКИМ ВЕЩЕСТВАМ	BS EN ISO 10545-13			
	RESISTANCE TO STAINS RESISTENZA ALLE MACCHIE RÉSISTANCE AUX TACHES RESISTENZ GEGEN FLECKEN RESISTENCIA A LAS MANCHAS СТОЙКОСТЬ К КРАСИТЕЛЯМ	BS EN ISO 10545-14			
	COLOUR RESISTANCE TO UV LIGHT RESISTENZA DEI COLORI ALLA LUCE UV RÉSISTANCE DES COULEURS À LA LUMIÈRE UV FARBRESISTENZ GEGEN UV-LICHT RESISTENCIA DEL COLOR A LA LUZ UV ЦВЕТООСТОЙКОСТЬ К УФ СВЕТУ	DIN 51094			

MAINTENANCE AND CLEANING OF TILES

MANUTENZIONE E PULIZIA DELLE PIASTRELLE | ENTRETIEN ET NETTOYAGE DES CARREAUX | PFLEGE UND REINIGUNG VON FLIESEN | MANTENIMIENTO Y LIMPIEZA DE AZULEJOS | ОБСЛУЖИВАНИЕ И ЧИСТКА ПЛИТКИ

Maintenance of ceramic and porcelain tiles on dry surfaces is relatively easy. RAK Ceramics tiles are highly scratch and stain resistant.

- By regularly sweeping the floor, you can help avoid scratches that small pebbles or sand can create.
- Make it a habit to always wipe the soles of your shoes on a mat before entering the house. Thoroughly wipe up any spills using plain warm water.
- While they are not likely to stain your ceramic tiles, spills may stain the grout between the tiles and if they are left to sit for too long, may also stain the actual tiles.
- Plain water is the ideal cleaner because it leaves no residue if you dry the surface of the tiles thoroughly after cleaning.
- If tiles are left wet after cleaning, there may be some unsightly mineral residue after the water dries, but this can easily be removed by spot cleaning.
- If stains resist cleaning with water alone, you can use a mild acidic solution, such as white vinegar. Use it highly diluted and rinse with plain water then dry.
- As food stains are acidic in nature, try using a mild alkaline solution.
- Use common detergents sparingly, rinse with plain water and dry thoroughly.

La manutenzione delle piastrelle ceramiche e porcellanate su superfici asciutte è relativamente semplice. Le piastrelle RAK Ceramics sono altamente resistenti ai graffi e alle macchie.

- Spazzando regolarmente il pavimento si contribuisce ad evitare eventuali graffi che possono essere causati da sabbia o pietrisco.
- Prendere l'abitudine di pulire la suola delle scarpe su uno zerbino prima di entrare in casa. Eliminare accuratamente ogni eventuale liquido versato mediante acqua naturale calda.
- Anche se è improbabile che macchino le piastrelle, eventuali liquidi versati possono macchiare lo stucco tra le piastrelle e se li si lascia agire troppo a lungo possono anche macchiare le piastrelle vere e proprie.
- L'acqua naturale è il detergente ideale perché non lascia residui se si asciuga attentamente la superficie delle piastrelle dopo la pulizia.
- Se le piastrelle vengono lasciate bagnate dopo la pulizia, quando l'acqua asciuga potrebbero verificarsi residui antiestetici, ma questi possono essere facilmente rimossi.
- Se in seguito alla pulizia con acqua naturale restano delle macchie, è possibile utilizzare una soluzione blandamente acida, come l'aceto bianco. Usarlo in forma diluita e sciacquare con acqua naturale, quindi asciugare.
- Poiché le macchie alimentari sono naturalmente acide, provare usando una soluzione leggermente alcalina.
- Usare i comuni detergenti con parsimonia, sciacquare con acqua naturale e asciugare con cura.

L'entretien des carreaux de céramique et de porcelaine sur des surfaces sèches est relativement facile. Les carreaux de RAK Ceramics ont une résistance remarquable aux rayures et aux taches.

- Le balayage régulier du sol permet d'éviter les éraflures que peuvent laisser les petits cailloux ou le sable.
- Prenez l'habitude de toujours nettoyer les semelles de vos chaussures sur un paillasson avant d'entrer dans la maison. Nettoyez soigneusement les déversements à l'aide d'eau ordinaire tiède.
- Bien qu'ils ne puissent pas tacher vos carreaux de céramique, les déversements peuvent teindre le coulis entre les carreaux. Par ailleurs, s'ils sont laissés pendant de longues durées, ces déversements peuvent également teindre les carreaux actuels.
- L'eau ordinaire est le nettoyant idéal car elle ne laisse aucun résidu lorsque vous séchez correctement la surface des carreaux après le nettoyage.
- Si les carreaux sont laissés humides après leur nettoyage, de résidus minéraux inesthétiques peuvent être notés après que l'eau ait séché, mais cela peut être facilement enlevé par un détachant.
- Si la tache résiste au nettoyage à l'eau, vous pouvez utiliser une solution acide douce comme le vinaigre blanc. Utilisez-le à l'état très dilué et rincez avec de l'eau ordinaire, puis séchez.
- Étant donné que les taches d'aliments sont de nature acides, essayez d'utiliser une solution alcaline douce.
- Utilisez des détergents usuels de manière modérée, rincez avec de l'eau ordinaire et séchez soigneusement.

294

Die Pflege von Keramik- und Feinsteinzeugfliesen auf trockenen Oberflächen ist relativ einfach. Die Fliesen von RAK Ceramics sind extrem widerstandsfähig gegen Kratzer und Schmutz.

- Durch regelmäßiges Fegen des Bodens können Kratzer vermieden werden, die durch kleine Steine oder Sand entstehen.
- Wischen Sie sich vor dem Betreten des Hauses die Schuhsohlen ab. Wischen Sie Verschüttetes gründlich mit warmem Wasser auf.
- Verschüttetes wird Ihre Fliesen nicht verfärben, kann jedoch in die Fugenmasse eintreten und diese kann dann, sollte das Verschüttete nicht aufgewischt werden, tatsächlich ihre Fliesen verfärben.
- Der ideale Reiniger ist einfaches Wasser, da es keine Rückstände auf der Oberfläche hinterlässt, wenn Sie die Fliesen nach Reinigung gründlich trocknen.
- Wenn Sie Fliesen nach dem Reinigen nicht trocknen können nach dem Abtrocknen des Wassers unschöne Rückstände von Mineralien bleiben. Diese können allerdings durch gründliche Reinigung entfernt werden.
- Sollten nach der Reinigung mit Wasser Flecken vorhanden sein, verwenden Sie eine milde, saure Lösung, z. B. mit weißem Essig. Verwenden Sie diese stark verdünnt, dann mit normalem Wasser gründlich abspülen und trocknen.
- Da Lebensmittelflecken von Natur aus sauer sind, versuchen Sie eine milde alkalische Lösung.
- Verwenden Sie ein wenig normales Reinigungsmittel, normales Wasser, und trocknen Sie die Oberfläche gründlich.

El mantenimiento de azulejos de cerámica y porcelana en superficies secas es relativamente fácil. Los azulejos de RAK Ceramics son altamente resistentes a rayones y manchas.

- Al barrer regularmente el piso, puede ayudar a evitar rayones que piedras pequeñas o arena pueden crear.
- Haga de limpiar las suelas de sus zapatos en una alfombra antes de entrar a la casa un hábito. Limpie minuciosamente cualquier derrame utilizando agua tibia.
- Aunque no es probable que manchen sus azulejos de cerámica, los derrames pueden manchar la lechada que se encuentra entre los azulejos y si se deja reposar por mucho tiempo, también puede manchar los azulejos mismos.
- El agua simple es el limpiador ideal porque no deja residuos si seca la superficie de los azulejos cuidadosamente después de limpiar.
- Si los azulejos se dejan mojados después de limpiarlos, puede que queden residuos minerales difíciles de ver a simple vista después de que se seque el agua; estos pueden ser fácilmente eliminados con limpieza de rutina.
- Si alguna mancha se resiste a la limpieza solo con agua, puede utilizar una solución ácida suave, como el vinagre blanco. Utilícelo bien diluido, lave con agua y séquelo al final.
- Debido a que las manchas de comida son naturalmente ácidas, intente utilizando una solución alcalina suave.
- Utilice detergentes comunes de vez en cuando, lave con agua y seque minuciosamente.

Обслуживание керамической плитки и керамического гранита на сухих поверхностях относительно простое. Плитка компании RAK Ceramics чрезвычайно стойка к механическим повреждениям и загрязнению.

- Регулярно подметая пол, вы помогаете избежать царапин, создаваемых мелким щебнем или песком.
- Сделайте привычкой всегда вытирать подошвы обуви о коврик перед входом в дом. Тщательно вытирайте любые разливы чистой теплой водой.
- Разливы вряд ли окрасят керамическую плитку, но могут окрасить раствор между плитками, а если вовремя не удалить разливы и оставить надолго, то могут окрасить саму плитку.
- Чистая вода — идеальное моющее средство, так как она не оставляет следов, если вы тщательно высушиваете поверхность после чистки.
- Если плитку после чистки оставить влажной, то на ней может остаться минеральный осадок, который, однако, легко удаляется пятновыводителем.
- Если пятна не удаляются водой, можно использовать мягкий кислотный раствор, такой как уксус. Используйте его сильно разбавленным, смывайте чистой водой и просушивайте.
- Так как пятна от пищи кислотны по своей природе, старайтесь использовать мягкий щелочной раствор.
- Экономно используйте общепринятые моющие средства, смывайте чистой водой и тщательно высушивайте.

295

R RATING TABLE

COLLECTIONS COLLEZIONI / COLLECTIONS / KOLLEKTIONEN / COLECCIONES / КОЛЛЕКЦИИ	TYPOLOGY TIPOLOGIA / TYPOLOGIE / TYPOLOGIE TIPOLOGIA / ТИПОЛОГИЯ	COLOURS COLORI / COULEURS / FARBEN / COLORES / ЦВЕТА	R N	R 3
CIRCLE WOOD	PORCELAIN TILES GRES PORCELLANATO GRÉS CÉRAMÉ FEINSTEINZEUG PORCELÁNICO КЕРАМИЧЕСКИЙ ГРАНИТ	GREY	R10 / A+B	-
		IVORY	R10 / A+B	-
		NUT	R10 / A+B	-
		BEIGE	R10 / A+B	-
		BROWN	R10 / A+B	-
CORAL STONE	PORCELAIN TILES GRES PORCELLANATO GRÉS CÉRAMÉ FEINSTEINZEUG PORCELÁNICO КЕРАМИЧЕСКИЙ ГРАНИТ	LIGHT GREY	R10 / A	R11 / A+B
		GREY	R10 / A	R11 / A+B
		IVORY	R10 / A	R11 / A+B
DESIGN CONCRETE	PORCELAIN TILES GRES PORCELLANATO GRÉS CÉRAMÉ FEINSTEINZEUG PORCELÁNICO КЕРАМИЧЕСКИЙ ГРАНИТ	WHITE	R10 / A	-
		LIGHT GREY	R10 / A	R11 / A+B
		GREY	R10 / A	R11 / A+B
		IVORY	R10 / A	R11 / A+B
		SAND	R10 / A	-
EVO CONCRETE		NUT	R10 / A	R11 / A+B
		ANTHRACITE	R9 / A	
		CEMENT	R9 / A	
		IVORY	R9 / A	
FLAG STONE	PORCELAIN TILES GRES PORCELLANATO GRÉS CÉRAMÉ FEINSTEINZEUG PORCELÁNICO КЕРАМИЧЕСКИЙ ГРАНИТ	LEAD	R9 / A	
		TORTORA	R9 / A	
		WHITE	R10 / A+B	-
		LIGHT GREY	R10 / A+B	-
HARD WOOD	PORCELAIN TILES GRES PORCELLANATO GRÉS CÉRAMÉ FEINSTEINZEUG PORCELÁNICO КЕРАМИЧЕСКИЙ ГРАНИТ	GRAPHITE GREY	R10 / A+B	-
		LIGHT SAND	R10 / A+B	-
		SAND	R10 / A+B	-
		IVORY	R10 / A+B	R11 / A+B
		BEIGE	R10 / A+B	R11 / A+B
K-ROCK	PORCELAIN TILES GRES PORCELLANATO GRÉS CÉRAMÉ FEINSTEINZEUG PORCELÁNICO КЕРАМИЧЕСКИЙ ГРАНИТ	RED	R10 / A+B	R11 / A+B
		BROWN	R10 / A+B	R11 / A+B
		MUD	R10 / A+B	R11 / A+B
		WHITE	R9 / A	-
		GREY	R9 / A	-
NEUTRA CONCRETE	PORCELAIN TILES GRES PORCELLANATO GRÉS CÉRAMÉ FEINSTEINZEUG PORCELÁNICO КЕРАМИЧЕСКИЙ ГРАНИТ	LIGHT GREY	R9 / A	-
		DARK GREY	R9 / A	-
		IVORY	R9 / A	-
		BEIGE	R9 / A	-
		BROWN	R9 / A	-
		CONCRETE LIGHT GREY	R10 / A	-
		CONCRETE IVORY	R10 / A	-
		CONCRETE GREY	R10 / A	-
		CONCRETE BEIGE	R10 / A	-
		IVORY	R10 / A	-

COLLECTIONS COLLEZIONI / COLLECTIONS / KOLLEKTIONEN / COLECCIONES / КОЛЛЕКЦИИ	TYPOLOGY TIPOLOGIA / TYPOLOGIE / TYPOLOGIE TIPOLOGIA / ТИПОЛОГИЯ	COLOURS COLORI / COULEURS / FARBEN / COLORES / ЦВЕТА	N	3
MAREMMA	PORCELAIN TILES GRES PORCELLANATO GRÉS CÉRAMÉ FEINSTEINZEUG PORCELÁNICO КЕРАМИЧЕСКИЙ ГРАНИТ	STEEL	R10 / A	-
		GREY	R10 / A	-
		DARK BROWN	R10 / A	-
		ORANGE	R10 / A	-
		SAND	R10 / A	-
		COPPER	R10 / A	-
SALENTO	PORCELAIN TILES GRES PORCELLANATO GRÉS CÉRAMÉ FEINSTEINZEUG PORCELÁNICO КЕРАМИЧЕСКИЙ ГРАНИТ	COTTO	R10 / A	-
		GREY	R10 / A	R11 / A+B
		BEIGE	R10 / A	R11 / A+B
SHINE STONE	PORCELAIN TILES GRES PORCELLANATO GRÉS CÉRAMÉ FEINSTEINZEUG PORCELÁNICO КЕРАМИЧЕСКИЙ ГРАНИТ	BROWN	R10 / A	R11 / A+B
		WHITE	R10 / A	R11 / A+B
		GREY	R10 / A	R11 / A+B
		DARK GREY	R10 / A	R11 / A+B
		BLACK	R10 / A	R11 / A+B
		IVORY	R10 / A	R11 / A+B
		BEIGE	R10 / A	R11 / A+B
		DARK BEIGE	R10 / A	R11 / A+B
SUGI BAN WOOD	PORCELAIN TILES GRES PORCELLANATO GRÉS CÉRAMÉ FEINSTEINZEUG PORCELÁNICO КЕРАМИЧЕСКИЙ ГРАНИТ	BROWN	R10 / A	R11 / A+B
		GURE GREY	R10 / A+B	-
		KASSHOKU BROWN	R10 / A+B	-
		BUGI BEIGE	R10 / A+B	-
		BORU BLUE	R10 / A+B	-
REVIVE CONCRETE XL	PORCELAIN TILES GRES PORCELLANATO GRÉS CÉRAMÉ FEINSTEINZEUG PORCELÁNICO КЕРАМИЧЕСКИЙ ГРАНИТ	SHIRO WHITE	R10 / A+B	-
		KURO BLACK	R10 / A+B	-
		ACTIVE WHITE	R10 / A	-
		CONCRETE GREY	R10 / A	-
		SUMMER SAND	R10 / A	-

COLLECTIONS	TYPOLOGY	COLOURS	N	3
REVIVE CONCRETE	PORCELAIN TILES GRES PORCELLANATO GRÉS CÉRAMÉ FEINSTEINZEUG PORCELÁNICO КЕРАМИЧЕСКИЙ ГРАНИТ	ACTIVE WHITE	R9 / A	R9 / A
		CONCRETE GREY	R9 / A	R9 / A
		GRAPHITE GREY	R9 / A	R9 / A
		PITCH BLACK	R9 / A	R9 / A
		CLOUD GREY	R9 / A	R9 / A
		SUMMER SAND	R9 / A	R9 / A
		BLADE BEIGE	R9 / A	R9 / A
EVOQUE METAL	PORCELAIN TILES GRES PORCELLANATO GRÉS CÉRAMÉ FEINSTEINZEUG PORCELÁNICO КЕРАМИЧЕСКИЙ ГРАНИТ	ICE	R9 / A	R10 / A
		GREY	R9 / A	R10 / A
		GREEN BLUE	R9 / A	R10 / A
		BROWN	R9 / A	R10 / A

CONTACTS :

**RAK Ceramics Corporate
Headquarters PJSC**

P.O. Box 4714, Ras Al Khaimah, United Arab Emirates (U.A.E.)
Tel. +971 7 2467000, Fax. +971 7 2445270 Email: info@rakceramics.com

**RAK Ceramics Distribution
Europe S.r.l.**

RAK Ceramics Distribution Europe Srl, Via Ferrari Carazzoli 21, 41042, Fiorano Modenese (MO) - Italy
Tel.: +39 0536 1888600, Fax: +39 0536 913920

RAK Ceramics GMBH

RAK Ceramics GMBH, Hanauer Landstraße 184, 60314 Frankfurt Am Main, Germany
Tel.: +49 (0) 6258 9418491, Fax: +49 (0) 6258 9418499

RAK Ceramics UK Ltd

RAK Ceramics UK Ltd, Bradford House, Frenchmans Road, Petersfield, Hampshire, GU32 3AW, UK
Tel. +44 1730 237850, Fax. +44 1730 263210

RAK
CERAMICS